

UltraPhoto 13

Pouch Laminator



Advanced Document Systems & Supply, Inc.
Phone: 800-808-2377 • Fax: 888-237-7329
www.adss.net

Instruction Manual

Introduction

Thank you for purchasing and using our laminator. You have purchased the finest laminator available in its class. It was designed and manufactured to provide you with the utmost in utility. As with any device that combines power and movement in its use, there are dangers if improperly used. At the same time, there are easier and faster ways for getting the job done if certain precautions are taken first. Please read this manual carefully. It contains useful ideas in obtaining the most efficient operation from your laminator and safety procedures you need to know before beginning use. When you follow our guidelines for operation, your laminator will give you many years of satisfying service. Thank you for choosing our product.

Contents

Introduction	01
Safety Precautions	02
Structure and Control Panel	04
Functions of Digital Display and Control Panel	05
Functions of Digital Display and Control Panel	06
Operating Instructions	
- Hot Laminating	07
- Cold Laminating	08
- Laminating Guide	09
Maintenance and Service	10
Specifications	10

Maintenance and Service

Maintenance

1. This machine is an electrical product, do not directly spray with water.
2. Before maintenance, disconnect the power supply.
3. Do not use gasoline, thinner or a metal brush to clean the machine.
4. Use a soft cloth to clean the dust. If the dust is thick, scrub it away with soap and water, then clean it with a dry cloth.

Service

If you need repair or service, please inspect the followings first:

- The plug is loose from the power socket.
- The power supply is cut off.
- The fuse in the machine is blown. (The fuse is installed on the back of the machine)







If repair service is required, please provide:

- Type of trouble • Model of machine • Serial number of machine

Specifications

Model	UltraPhoto 13
Max. Laminating Width	13"
Max. Laminating Thickness	1mm
Laminating Speed	11" - 60" a minute
Hot Laminating Temp.	51 °C - 160 °C
Cold Laminating Temp.	0 °C - 50 °C
Warm up time	5 minutes
Control System	8 bit Micro-Processor, 10 bit A/D
Display System	Digital Display
Cooling System	DC Fan
Driving Motor	DC Gear Speed Adjustable Motor
No. of Rollers	6 Pcs. (4 pcs for heating)
Power Supply	AC 100, 110, 220 - 240 V / 50Hz, 60Hz
Power Consumption	1150 w
Dimensions	21 3/4" L x 11 3/4" W x 5 1/2" H
Weight	37 1/2 lbs.

Safety Precautions

 Warning 	
Please do not use broken, aging or self made electrical wire. To avoid fire do not twist or enlance the electrical wire.	
If the supplied Power cord is damaged, it must be replaced by the our service agents to avoid a hazard.	
To avoid electric shock and fire do not use a power supply that is not in accordance with the rated voltage.	
	Do not attempt to repair the machine yourself
	Avoid wearing a neck tie, necklace or anything that will get entangled in the running rollers. In case that something is entangled press the Reverse button or unplug the machine immediately.
	Do not open the machine for risk of electric shock. Keep the machine and power cord away from water and other liquids. Unplug the power supply to move the machine. Never operate the machine with the cover open.
	Do not put anything on the machine while the machine is on. Do not insert any material that is easily burned or that can melt into the machine.

Speed and Temperature Settings

Film Thickness	Paper	Settings without Carrier		Settings with Carrier	
		Temp.	Speed	Temp.	Speed
3mil	Copy Paper (80 gsm)	100 °C	7	110 °C	6
	Art Paper (120 gsm)	100 °C	7	110 °C	6
	Hard Paper (200 gsm)	100 °C	6	110 °C	6
5mil	Copy Paper (80 gsm)	110 °C	6	120 °C	5
	Art Paper (120 gsm)	110 °C	5	120 °C	5
	Hard Paper (200 gsm)	120 °C	5	130 °C	4
7mil & 10mil	Copy Paper (80 gsm)	130 °C	5	130 °C	4
	Art Paper (120 gsm)	130 °C	5	130 °C	4
	Hard Paper (200 gsm)	130 °C	4	130 °C	4

Safety Precautions

⚠ Warning ⚠	
Working Place	This Machine should be operated in a dry clean place. You should use this machine on a level sturdy area with enough room for the document to enter and exit the machine
Pouch Film	Only use quality laminate pouches to avoid cheap laminate to get entangled in the machine. The length and width of the pouch should be 3-5mm larger than the document being laminated Do not use single sided Laminate in this machine Do not laminate hard materials like coins, wood, metal, etc.
Machine Operation	Do not use this machine for anything other than laminating pouches. When not operating turn the machine off. If any problems occur with the machine do not use the machine in a damaged state. Contact your service tech for repair needs.
Hints	
<ul style="list-style-type: none"> • Do not use this machine for anything other than laminating pouches. • When not operating turn the machine off. • If any problems occur with the machine do not use the machine in a damaged state. Contact your service tech for repair needs. • Laminate can not be removed, your original document will meld permanently to the plastic 	

Operating Instructions

Temperature Adjustment

There are Temp control keys on the control panel. Different pouch film, different document, different room Temp, should have different working Temp. If the laminated document is not clear, it might be because the Temp is low, increase the Temp by 5°C, then laminate it again, until a perfect laminated document appears. If the Temp is too high, the laminated document will be corrugation, if so, decrease the Temp until get the perfect laminated document.

Note: If the best working Temp is not clear, set Temp 80°C and the speed to 3 first, then make adjustment according to the laminating result. Do not set the Temp more than 120°C, this might melt the laminating film.

Cold Laminating

1) Preparation

Turn on the power switch, the display light will turn on. The Temp must be set to less than 50°C. The suggested Temp is below 40°C and the suggested speed is 1- 4.

2) PVC film

Take off a little glue side of the PVC film from the under cover paper.

Note: Do not uncover too much pvc film from the under cover paper, remove the pvc film from the under cover paper entirely, this will make the pvc film useless.

3) Cold laminating

Put the glue side of PVC film on the front of document parallel, make the glued end in front, place it between the two convex line on the input board. Slightly place the document at the middle of inlet, keep the document in alignment with the inlet. Steadily remove the under cover paper from the PVC film in the opposite direction. (Shown as FIGURE 2)

Figure 2

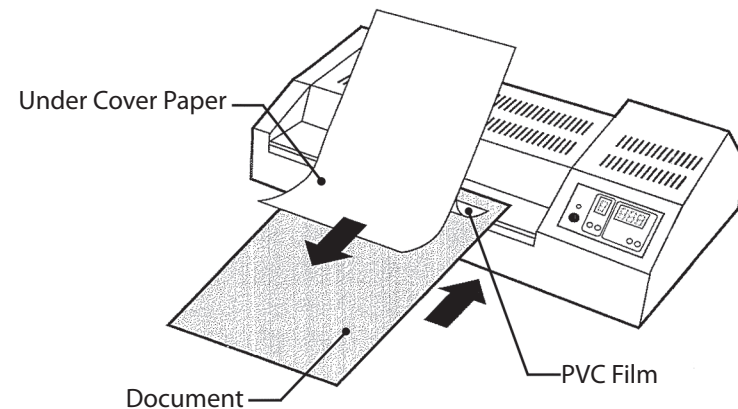

Operating Instructions

Connecting To The Power Source

- 1) Check the rated voltage on the machine, to insure it conforms to the power source. Also, check the plug to insure it conforms to the socket.
- 2) If the electric wire does not connect with the machine, connect it with the wire socket on the back of machine.

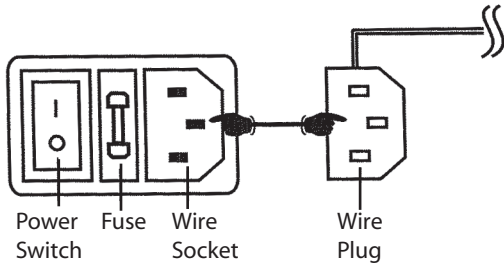

2. Hot Laminating

1) Preparation

Turn on the power switch, the display light will turn on. Set the Temp to more than 60° C, the machine will begin warming up. When the Temp increase to the setting Temp, the constant Temp lamp turns on. Wait for around 2 minutes so the temperature can get stable, then you can begin laminating. During the working period the temperature constant light will be on it indicates that the machine is ready to laminate.

2) Hot laminating

Put the paper into the pouch film, and make sure the sealed end of pouch is in front, then insert it into the machine. (Shown as FIGURE 1). If put other sides in front, it will bring fold or the machine is blocked. If the document gets jammed, press the Reverse button, the motor will reverse, and the paper will withdraw. When inserting the pouch film into the machine, insure it is between the two convex line's on the input board. Now, the whole laminating operation is finished, a perfect laminated document will appear on the output board.

Figure 1

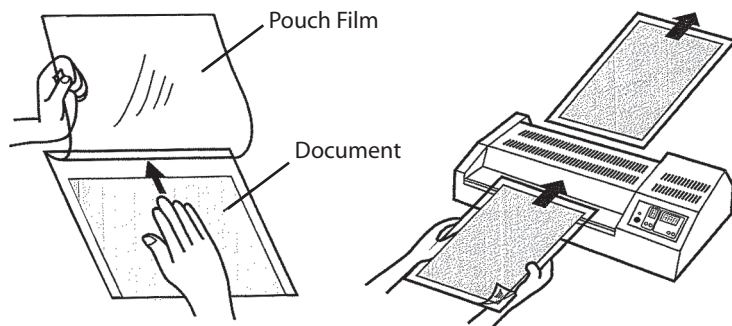

Structure and Control Panel

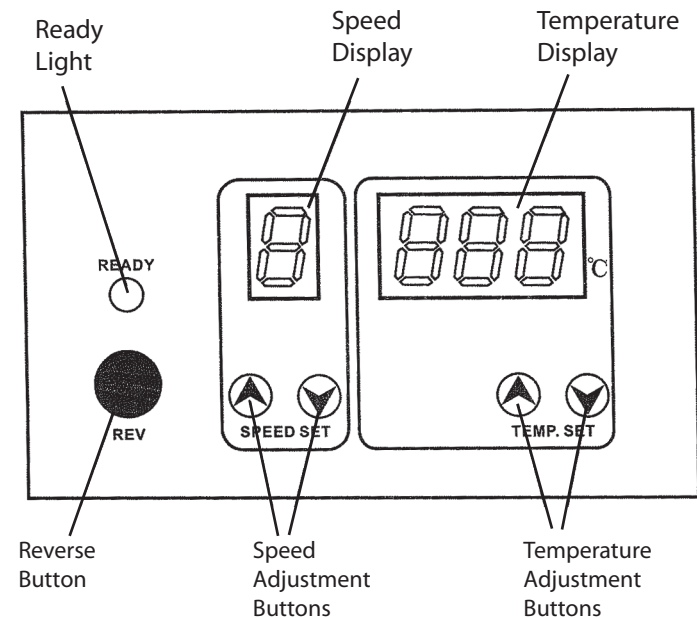
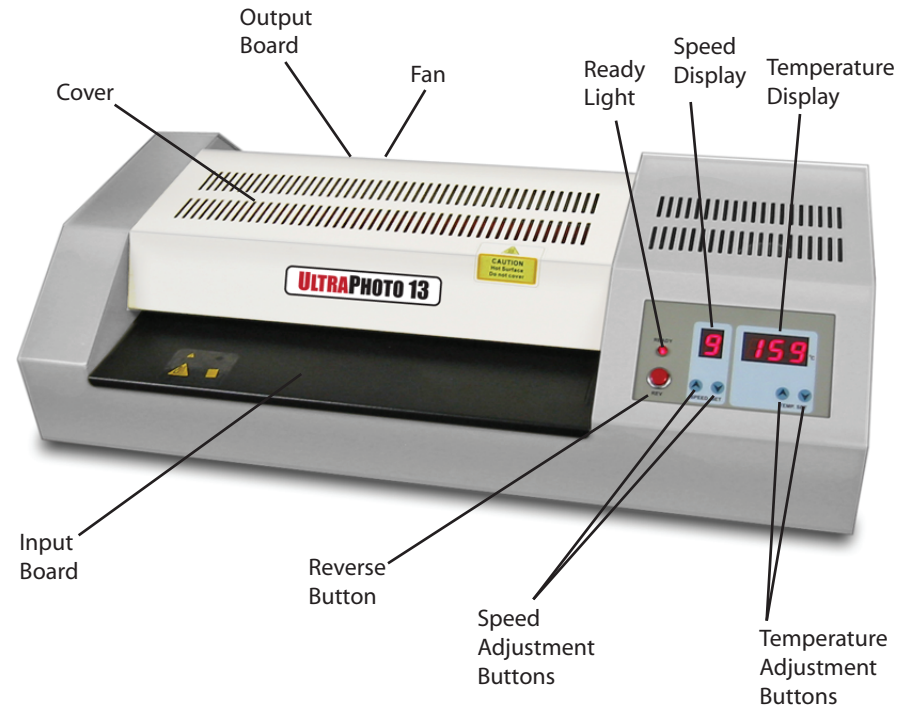

Functions of Digital Display and Control Panel

1. Digital Display and Functions

1) Sleeping Function



OFF

A) If a document is not passed through the machine in 60 minutes, it will automatically enter a sleeping mode

Note:

- 1) While in sleeping mode, the machine will stop heating.
- 2) The temperature display shows OFF.
- 3) The Warning beep will be heard every 6 seconds.
- 4) After the roller Temp decrease below 60°C, the motor will be turned off automatically.

B) How to wake up from sleep mode

- 1) Press any key
- 2) Restart the power supply

2) Protecting function of temperature sensor's open circuit and short circuit



OPN

When the sensor is in open circuit, shows OPN



CLS

When the sensor is in short circuit, shows CLS

3) Over-heat protecting function

When the roller temperature is over 160°C, the over-heat protecting circuit will turn off the heat automatically.

4) Auto memory function

The machine will automatically remember the last temperature and speed setting you used.

Functions of Digital Display and Control Panel

1. Button Function of Control panel

1) Temperature Control Buttons



- A)** These can be used for increasing or decreasing the temperature manually. The temperature can be increased or decreased by 1°C when these keys are pressed. Pressing the key continuously will change the temperature until you stop pressing the key
- B)** The range of temperature that can be adjusted manually is (0°C - 160°C) When the temperature is over 160°C, the over-heat protecting system will turn off the heat.
- C)** When pressing the temperature adjust keys, it indicates the set temperature when you do not press the key for 3 seconds it will indicate the present temperature.
- D)** When the temperature reaches the set heat the temperature ready light will turn on

2) Speed Control Buttons



- A)** These will increase or decrease the speed manually.
- B)** The range of speed settings are 1 through 9
- C)** Roll Heat Stand By:
 - I.** If the set temperature is less than 90°C, when the actual temp of the roller is 30°C below the set temperature the motor will start. For example, if the set temperature is 85°C, when the actual temperature of the roller is less than 55°C the the motor will not run. Once the actual temperature reaches 56°C the motor will start
 - II.** If the set temperature is more than 90°C when the actual temperature of the roller is 60°C the motor will start. This will protect the machine

3) Reverse Button



REV

Use the reverse function in case the laminate gets tangled or jammed in some way or if an article not supposed to be in the rollers gets jammed.