

MBM BC-10 BUSINESS CARD CUTTER OPERATION MANUAL



Tokyo, August 1, 2006

CONTENTS	
SPECIFICATIONS	1
EXPLANATION OF SYMBOLS	2
SAFETY INSTRUCTIONS	3
1. PRECAUTION OF INSTALLATION	6
2. OVERVIEW	8
3. UNPACKING AND SETUP	10
4. LAYOUT AND PRINTING	11
5. PREPARATION FOR CUTTING	14
6. OPERATION	15
7. MAINTENANCE	20
8. OPTIONAL PARTS	22
9. TROUBLESHOOTING	23

SPECIFICATIONS

Paper Size	Letter size	A4 size
Cutting Size	2.0" x 3.5" (50.8mm x 89mm)	55 x 90mm or 51 x 90mm
Cutting Format	Single cut (US size) Double cut (US size)	Single cut (Standard size) Double cut (Standard size) Double cut (US size)
Cutting Thickness	6/1000" to 12/1000" (0.15 to 0.30mm), Approx. 110 to 302g/m ²	
Speed	100 cards (10 sheets) per minute (Single cut)	
Sheet Stacking Capacity	50 sheets (Sheet thickness: 0.20mm / 0.008")	
Counter	Addition and preset subtraction	
Dimensions	23.0" (W) x 16.9" (D) x 12.8" (H) / 585 (W) x 428 (D) x 325 (H)mm	
Net Weight	46.3lbs. / 21.0kg	
Power Source	115V/60Hz	
Power Consumption	32W	

Thank you for selecting the MBM BC-10 BUSINESS CARD CUTTER.









- ◆ The BC-10 BUSINESS CARD CUTTER is designed to cut an A4-sized or letter-sized sheet into 10 business cards.
- ◆ Please read this Operation Manual thoroughly prior to operation.
- ◆ Keep the Manual nearby for future reference.
- ◆ Please be sure to include the Manual with the machine when you sell or rent it to anyone else.

EXPLANATION OF SYMBOLS









You will find following symbols in this Manual and on labels attached onto the machine.

 **DANGER**, identifies an imminently hazardous situation which, if not avoided, could result in death or serious injury.

 **CAUTION**, identifies a potentially hazardous situation which, if not avoided, may result in minor injury or property damage incidents.

 Prohibited	 Do not disassemble	 Do not touch with wet hands
 Do not expose to wet conditions	 Unplug	 Need to Ground
 General Instruction	 Risk of electric shock	

SAFETY INSTRUCTIONS

 DANGER	
	Connect the power cord directly into a wall-mounted outlet of appropriate voltage. To avoid the risk of fires or electric shock, do not connect to a multiple outlet strip.
	Do not plug into an outlet of a voltage that is different from the one marked on the serial tag. Operating on an incorrect voltage can cause fires or electric shock.
	Do not connect or disconnect the power cord with wet hands in order to avoid electric shock or fires.
	To avoid the risk of fires or electric shock, do not abuse the power cord. Do not ①put excessive weight on the cord, ②pull without holding the plug, ③bend excessively, or ④modify the cord.
	If a sheet is stuck in the Cutter Unit, ①clear the error, ②press the start button to open the cutter, and ③turn off the Power Switch before removing the paper.
	Do not remove the transparent cover of the trash box. It is part of the safety cover of the Slitter Unit, which keeps operator's hands from being injured while the Card Stacking Box has been removed.
	Do not expose the BC-10 to rain or wet conditions in order to avoid fires or electric shock.
	If you notice a strange sound or smell while the BC-10 is running, turn off the Power Switch immediately and remove the plug. Call your supplier for repair.

 **CAUTION**



Do not connect the power cord to an outlet when the plug is dusty. Make sure the plug fits completely into the outlet.



Do not use a power cord that is not attached to the BC-10.



Do not use the attached power cord for other use.



To avoid the risk of fires or electric shock, do not operate the BC-10 without grounding. If a three-hole outlet is not available, be sure to ground the power cord with the adapter.



Do not disassemble the Cutter Unit.



Do not disassemble the Slitter Unit.



Be sure to turn off the Power Switch before removing jammed paper.



When you move the BC-10, lift from the bottom. The BC-10 weighs about 46 lbs. (21.0kg).



Do not rub the edges of paper in order to avoid the risk of injury.

 **CAUTION**



Do not use the BC-10 in dusty or damp conditions in order to avoid the risk of fires or electric shock.



Do not put the BC-10 in an unstable place in order to avoid the risk of falling down.



Remove the plug from the outlet if the BC-10 will not be in use for a long period.



Never use the cord to pull the plug from an outlet.



Clean up the blades of the plug periodically. Dust on the blades can cause fires.



Turn off the Power Switch and disconnect the plug before moving the BC-10.

1. PRECAUTION OF INSTALLATION

CAUTION

Put the machine on a flat, level and stable surface.

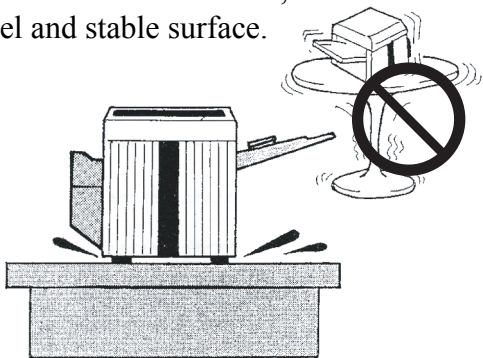

Do not use in temperatures less than 50° or higher than 100° Fahrenheit and in humidity less than 50% or higher than 80%.

CAUTION

Keep the machine away from dusty locations.

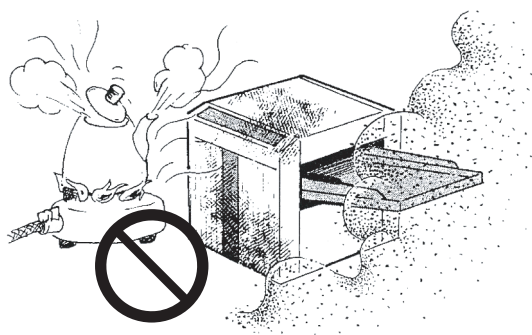

CAUTION

Keep the machine away from heating devices or fires.

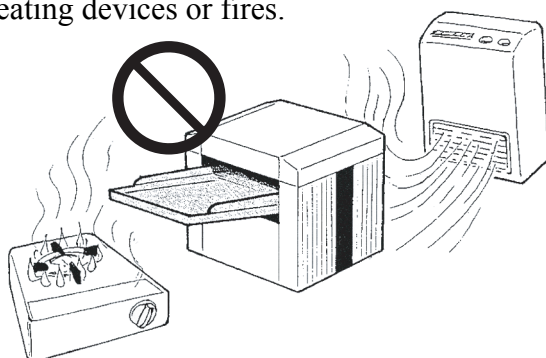

CAUTION

Do not leave the machine in direct sunshine.

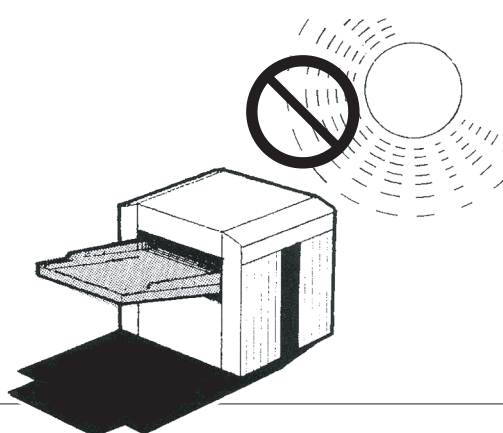

CAUTION

Avoid dropping or bumping the machine.

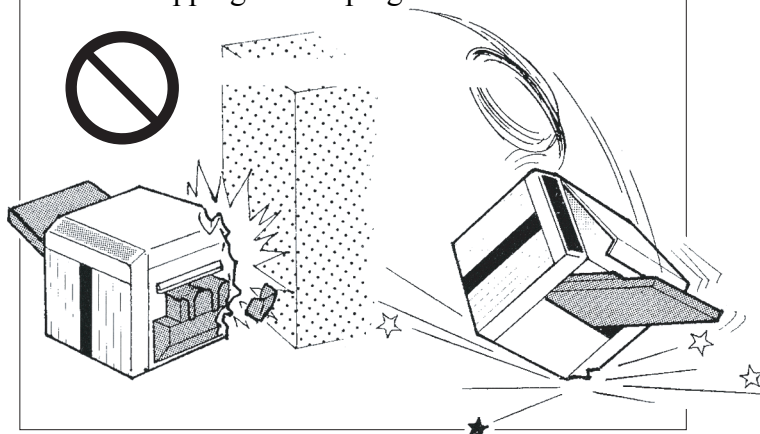

⚠ DANGER

Do not expose the machine to wet conditions. Do not put anything on the Upper Cover.

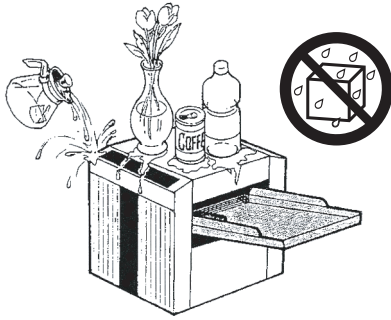

⚠ DANGER

Do not connect or disconnect the power cord with wet hands in order to avoid electric shock.

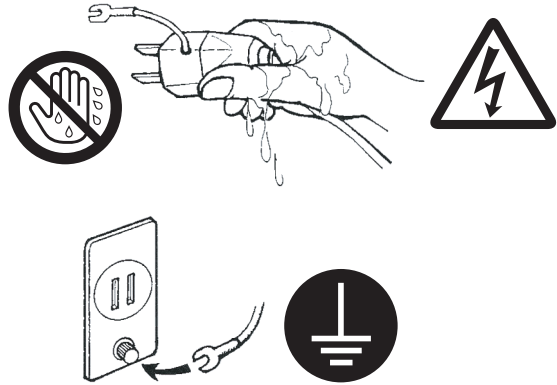

Be sure to ground the machine.

⚠ DANGER

Make sure the voltage of the outlet is consistent with the voltage marked on the serial tag.

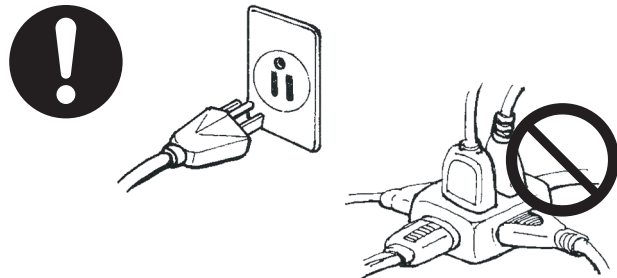

Connect the machine directly to a wall-mounted outlet.
Do not connect to a multiple outlet strip.

⚠ CAUTION

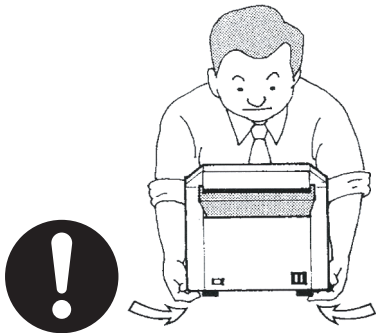

Grip on the bottom to carry the machine.

⚠ CAUTION

Do not operate in excessive cold or heat.

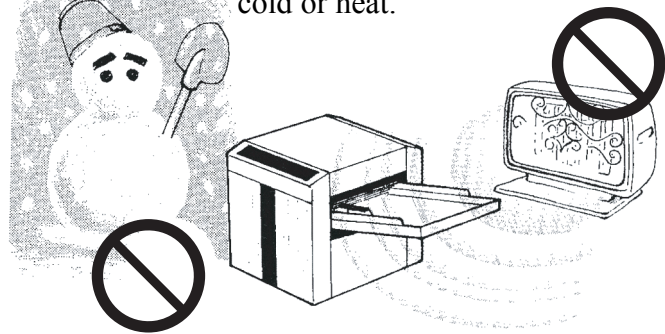

2. OVERVIEW

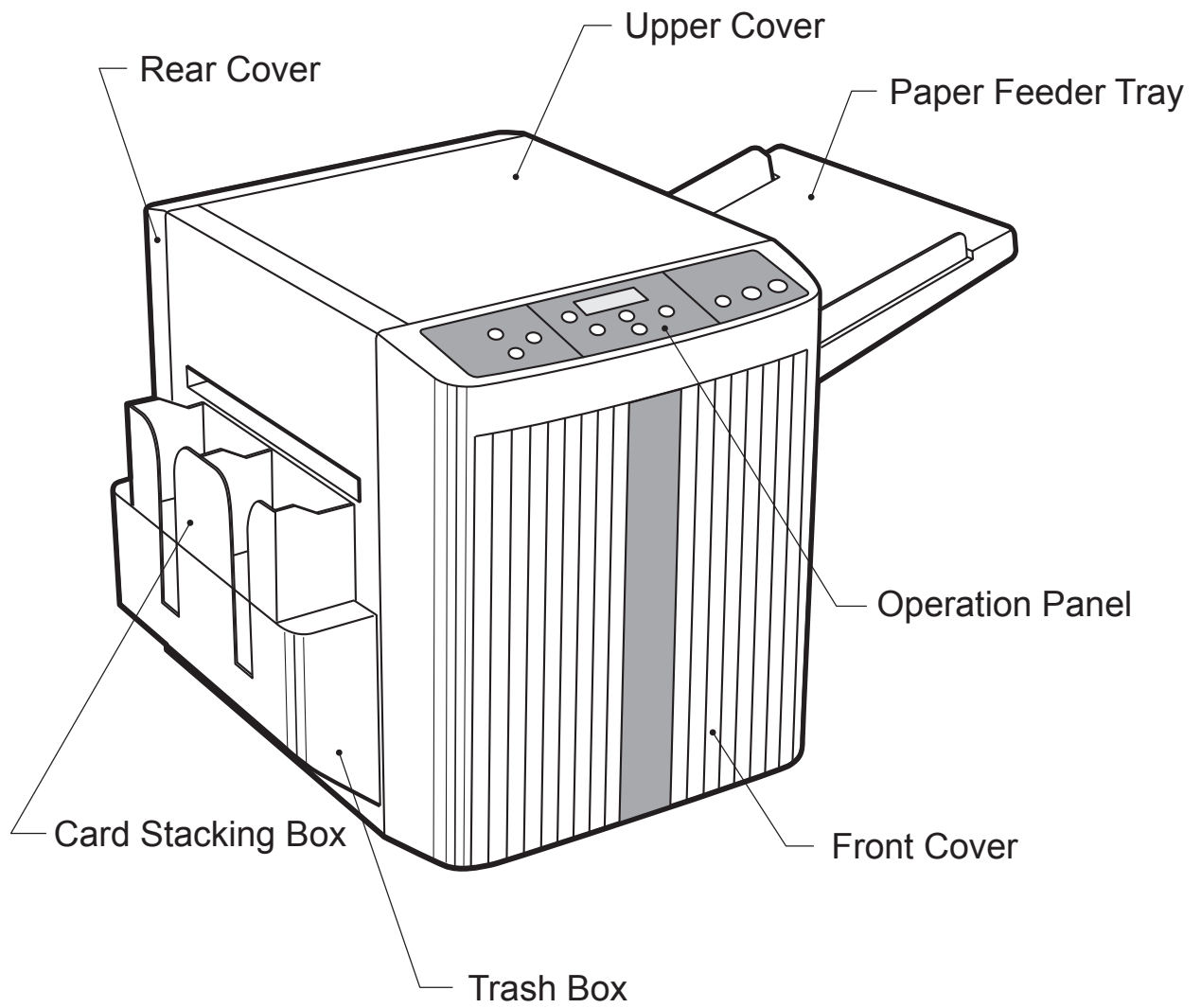

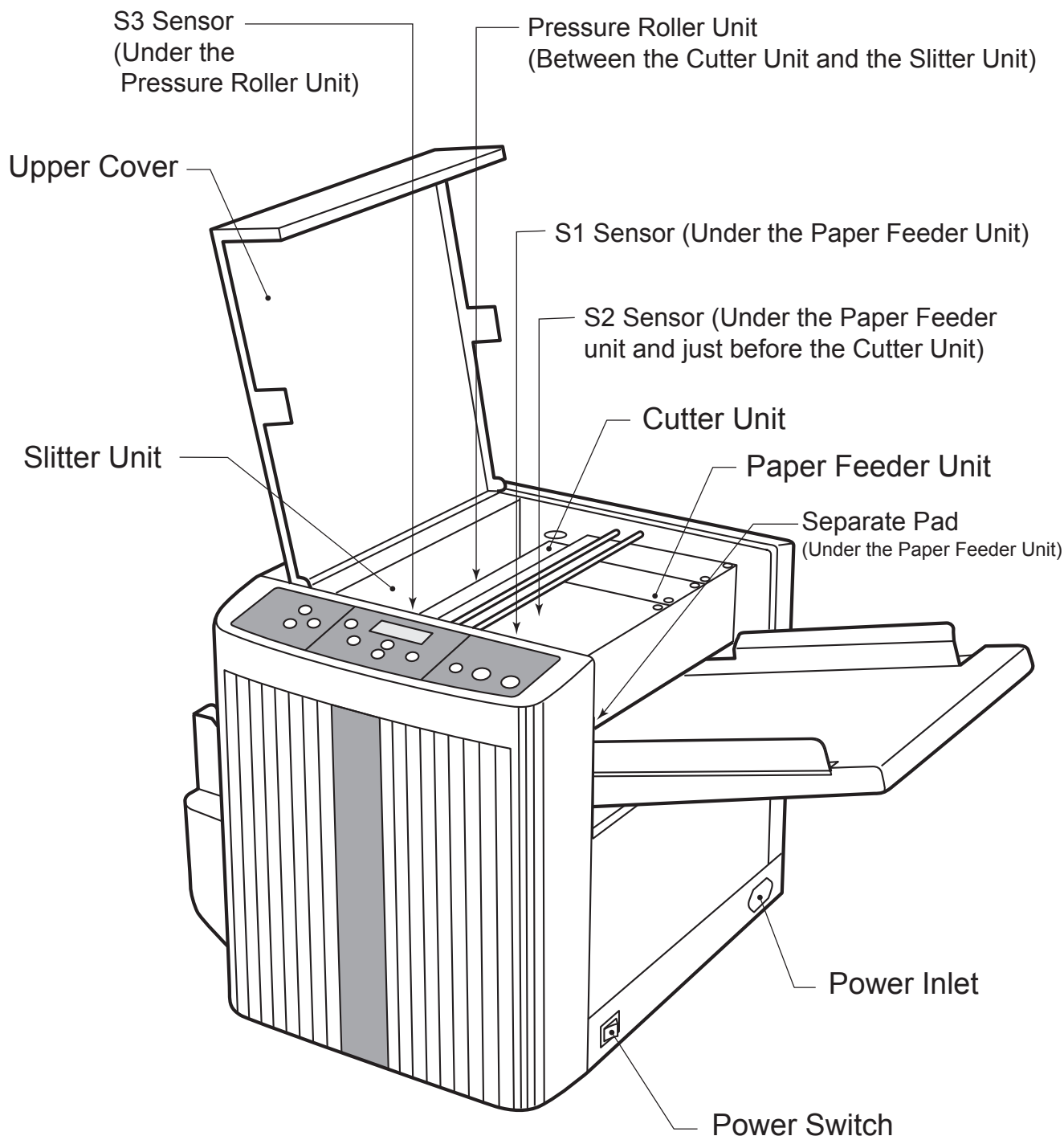

3. UNPACKING AND SETUP

3.1 Confirm that all components are present.

Check the items below. Call the supplier if anything is missing.

- BC-10
- Paper Feeder Tray
- Power Cord with two-pronged adaptor (in the Trash Box)
- Trash Box and Card Stacking Box (in the Trash Box)
- Operation Manual and 5 Test Sheets

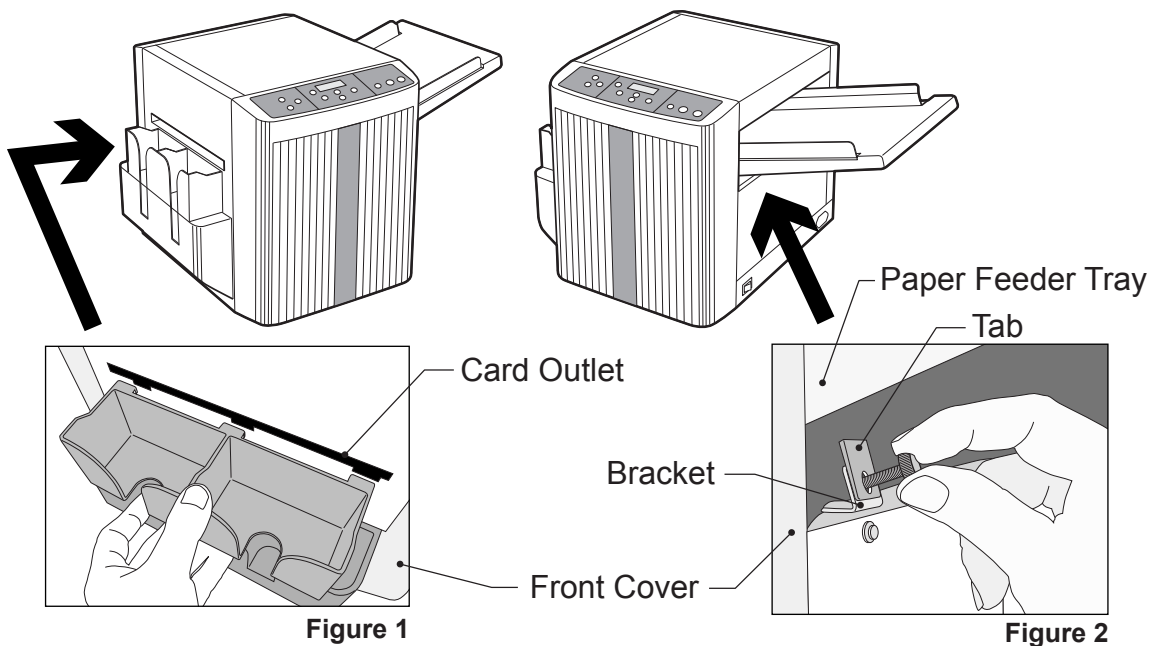

3.2 Setup

1. Place machine on a stable surface. See the figures.
2. Insert the Paper Feeder Tray along the guide rails until it stops.
3. Attach the two tabs under the Paper Feeder Tray to the brackets of the machine with provided screws. Make sure the Paper Feeder Tray is securely fixed to the machine. See **Figure 2**.
4. Insert the Trash Box and hang the Card Stacking Box on the verge of the Card Outlet. See **Figure 1**.
5. Connect the Power Cord to a 120VAC outlet. If a three-hole outlet is not available, ground the machine with the attached adaptor.

3.3 Packing Box

Keep the packing box and styrofoam. You may need these to transfer the machine.

4. LAYOUT AND PRINTING

4.1 The BC-10 cuts the following kinds of paper (See **SPECIFICATIONS**).

- ◆ A4-sized paper (297 x 210mm)
- ◆ Letter-sized paper (8.5" x 11")

The BC-10 has 5 cutting modes:

- ◆ 3 modes for A4-sized paper
- ◆ 2 modes for Letter-sized paper

4.2 Set up layouts according to the standard layout patterns shown on page 12 and 13. Microsoft Word contains templates for business cards or graphic programs such as Adobe Illustrator or PageMaker may be used.

4.3 If your printer cannot precisely position the images on the sheet, the BC-10 can be adjusted during the cutting procedure (See **6.9** and **6.11**).

4.4 Print required number of sheets. One sheet makes 10 cards.

4.5 The heat of the printer can make sheets curl. These curls can cause paper jams or affect cutting accuracy. Straighten out paper as much as possible before cutting.

4.6 Be sure to use short-grained papers (papers with the grain direction along the 8.5" or 210mm sides).

**Standard Layouts
for Letter-sized paper**

Unit: inch (mm)

2 x 3.5 inches single cut
(50.8 x 89mm)

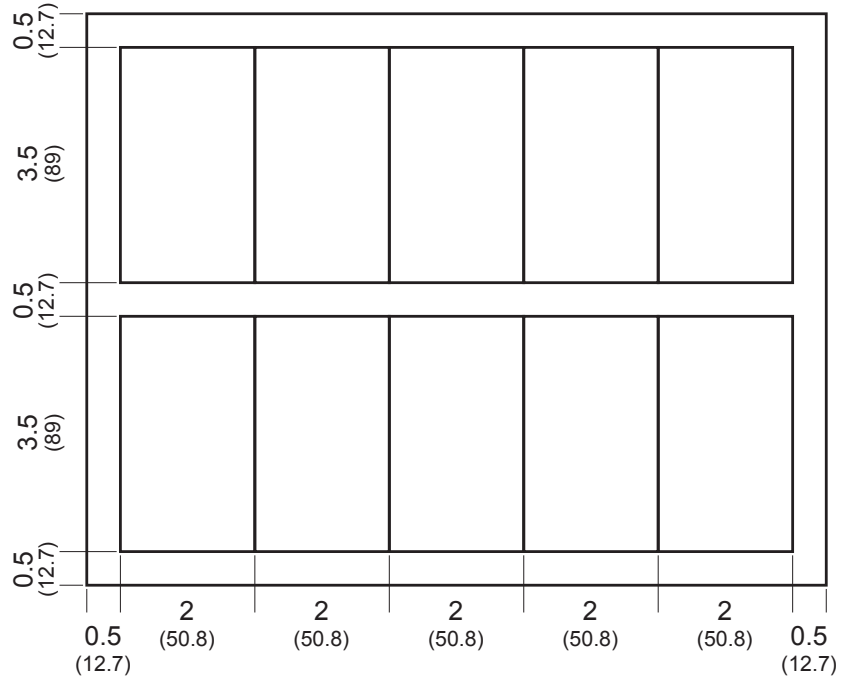

2 x 3.5 inches double cut
(50.8 x 89mm)

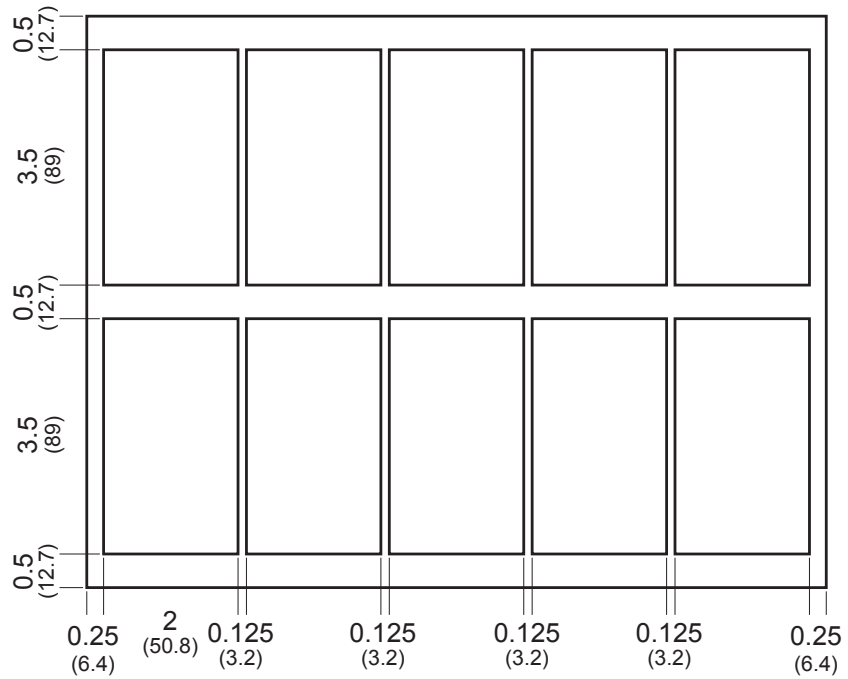

**Standard Layouts
for A4-sized paper**

Unit: mm

55 x 90mm single cut

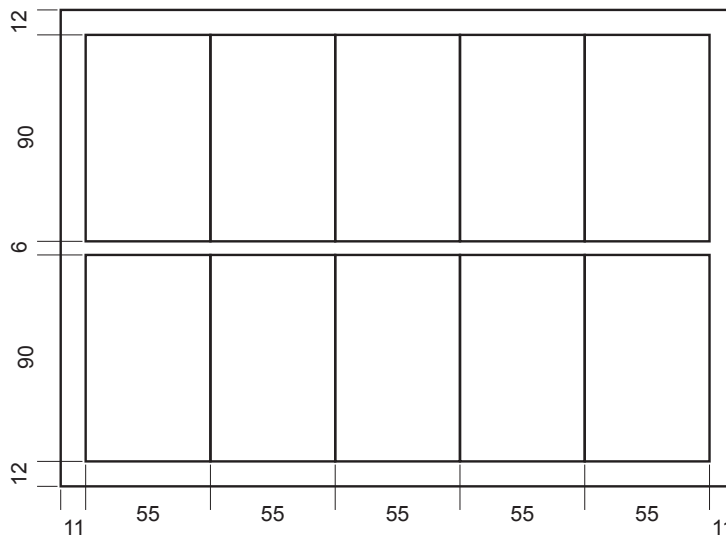

55 x 90mm double cut

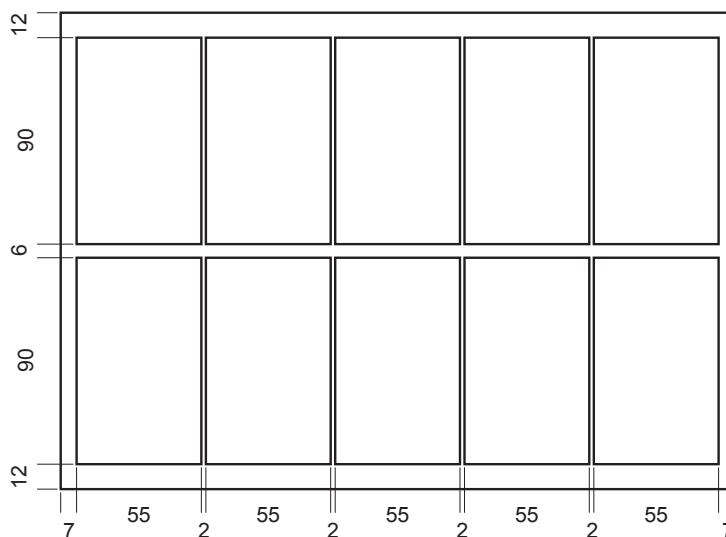

51 x 90mm double cut

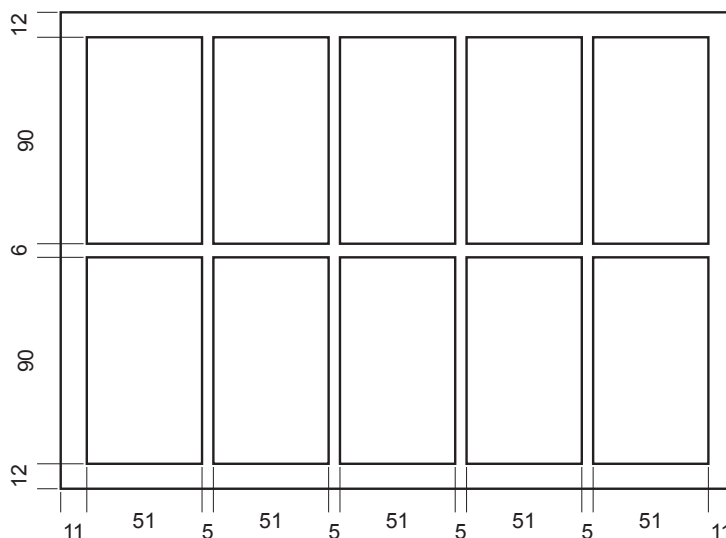

5. PREPARATION FOR CUTTING

- 5.1** Use the BC-10 only in the conditions described in the **PRECAUTION OF INSTALLATION** section.
- 5.2** Make sure the Power Switch is off.
Connect the power cord into a wall-mounted outlet.
- 5.3** If a three-hole outlet is not available, ground the power cord with the adapter.

 **DANGER:** Do not connect or disconnect the power cord with wet hands in order to avoid electric shock.

 **CAUTION:** Never use the cord to pull the plug from an outlet.

- 5.4** To set the paper
1. Jog a stack of sheets.
 2. Place the stack on the Paper Feeder Tray face-up.
 3. Press down the Left Paper Guide on the Paper Feeder Tray to turn the feeding status "off."
 4. While pressing down the Left Paper Guide, slide the paper down until it stops.
 5. Release the Left Paper Guide to turn the feeding status "on."
 - ◆ Load limit is 50 sheets (Sheet thickness: 0.20mm / 0.008").
- 5.5** Turn on the Power Switch.
The Display in the center of the Operation Panel will light up.

6. OPERATION

[Operation Panel]

- Note: ♦ Do not use excessive force to push the buttons.
 ♦ Confirm your selection with the LED lights.

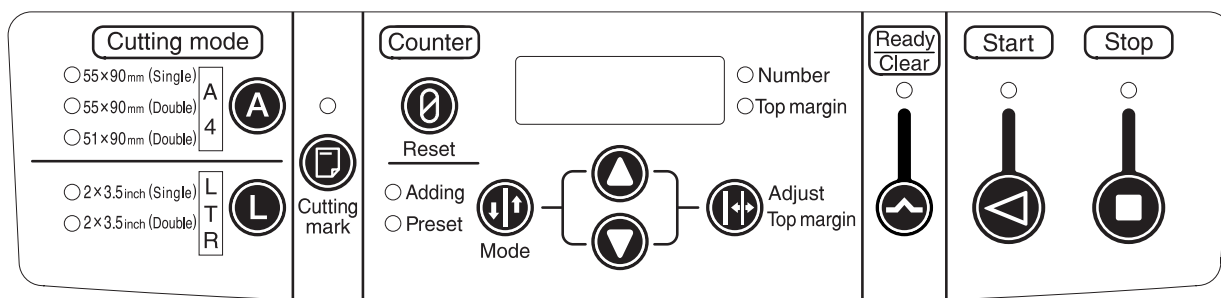

- 6.1** With the Upper Cover being open, the BC-10 will not go on if you turn on the Power Switch.
 Shut the Upper Cover.
- 6.2** With the Trash Box being dislocated, the BC-10 will not go on if you turn on the Power Switch.
 Insert the Trash Box completely.
- 6.3** To clear errors, refer to the list of error codes below and press the Ready/Clear button.

Error Code	Description
E002	Malfunction of the sensor in the Cutter Unit. (Or the malfunction of the Cutter Unit.)
E003	The Slitter Unit is not set properly.
E006	A sheet or cut fragment has stopped at the S2 sensor.
E007	Paper conveying problem (S3 sensor timeout: a sheet did not reach the S3 sensor in time).
E008	Paper conveying problem (S3 sensor timeout: a sheet did not transit through the S3 sensor in time).

6.4 The "Ready" LED turns on and the number of the finished cards of the last job appears in the Display after all errors are cleared.

6.5 Press the Counter Reset button (for a couple of seconds) to reset the number.

6.6 To select Cutting modes

A green LED indicates the present Cutting mode. The mode used for the last job is the default. Press the "A" or "L" buttons to select your desired mode.

Note: ♦ The 3 modes for A4-sized paper can be selected when a Slitter Unit for the A4-sized is attached.

♦ The 2 modes for Letter-sized paper can be selected when a Slitter Unit for the Letter-sized is attached.

♦ "E003" appears in the Display with no Slitter Unit being attached.

6.7 To select the Cutting Mark function

To use the Cutting Mark function, you have to print a "Cutting Mark" on your business card layout at the same time. The Cutting Mark is a black rectangle, which size is 2mm x 31mm (0.08" x 1.22"), to tell the machine where to start cuttings.

♦ Press the Cutting mark button to turn on the Cutting Mark function (The red LED turns on).

♦ Press the Cutting mark button again to turn off the Cutting Mark function.

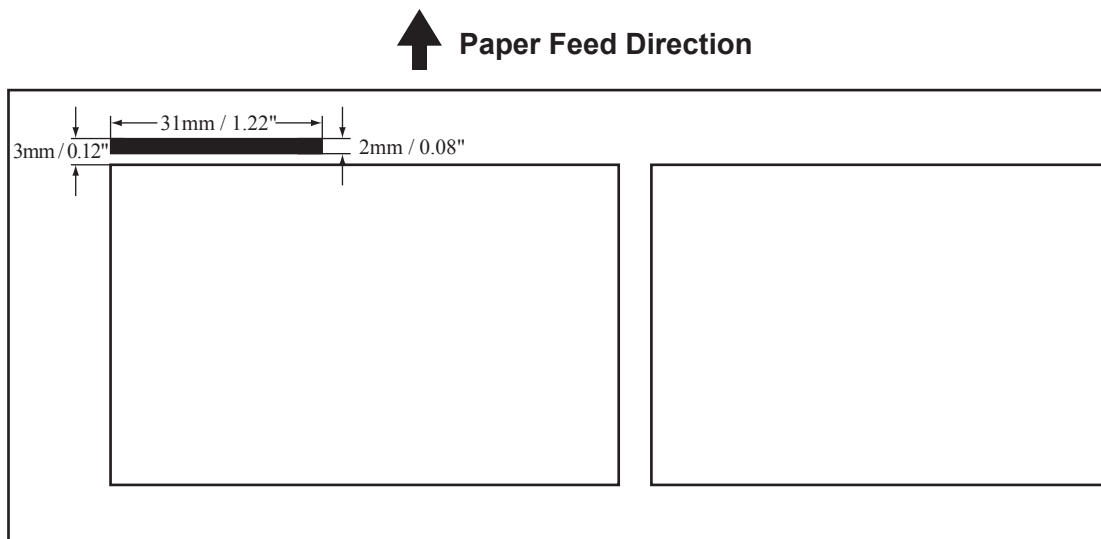

While the Cutting Mark function is on, the system starts cutting at the line which is 3mm behind the lead edge of the Cutting Mark. Manually-set Top Margin length is ignored. The resulting cuts (2nd, 3rd, 4th...) are done according to the selected Cutting mode's layout pattern (See page 12 to 13).

- ◆ The Cutting Mark must be printed in black in order to be read by the sensor. Colored paper (especially dark colors) can also prevent the sensor from reading.
- ◆ The maximum printing area varies. Some printers cannot always print the Cutting Mark. In that case, enlarge the "Upper Margin" so that the Cutting Mark can be printed.

Note: Be sure to keep the Top Margin length within the Upper Limit of each cutting mode. Refer to **6.9** and the Top Margins table on page 18.
- ◆ With the Cutting Mark function being on, pre-printed logos or marks will not be always located in the proper position when cards are finished.
- ◆ The BC-10 will stop if you try to cut sheets without a Cutting Mark while the Cutting Mark function is on.
- ◆ When the Cutting Mark function is off, the BC-10 cuts sheets according to a manually-set Top Margin length of the selected Cutting Mode. Printed Cutting Marks are ignored.

6.8 To select Counter Modes

Press the Mode button to select "Adding" or "Preset."

- ◆ When "Adding" is selected, the "Adding" LED turns on. The number of the Counter increases by twos as the BC-10 goes on cutting.
- ◆ When "Preset" is selected, the "Preset" LED turns on. Press ▲ or ▼ to increase/decrease the "Preset" number in the Display by tens. The number of the Counter decreases by tens as the BC-10 goes on cutting.
- ◆ With the "Preset" mode, the machine stops cutting and goes "Ready" when the Counter comes down to "0000." Two seconds later, the Counter shows the "Preset" number again.

6.9 To adjust the Top Margin

- ◆ Once you press the Adjust Top margin button, the "Top margin" LED turns on and the Top Margin value used in the last job appears.
- ◆ Standard Top Margin lengths are shown in page 18.
- ◆ When you browse Cutting Modes, the standard Top Margin length for each Cutting Mode appears. Press ▲ or ▼ to increase/decrease the Top Margin length one step at a time. Press the Adjust Top margin button to save the value and return to the Counter Display.

6.10 When all settings for Cutting Modes and Counter Modes are finished, start the job by pressing the Start button.

The "Start" LED turns on and the BC-10 begins cutting sheets.

Top Margins

Cutting Mode	Standard Top Margin	Upper Limit	Lower Limit	Adjusting Step
55 x 90 mm single cut	11 mm (0.433 in.)	14.0 mm (0.551 in.)	8.0 mm (0.315 in.)	0.25 mm (0.010 in.)
55 x 90 mm double cut	7 mm (0.276 in.)	8.0 mm (0.315 in.)	6.0 mm (0.236 in.)	0.25 mm (0.010 in.)
51 x 90 mm double cut	11 mm (0.433 in.)	14.0 mm (0.551 in.)	8.0 mm (0.315 in.)	0.25 mm (0.010 in.)
2 x 3.5 inches single cut	0.5 in.	0.610 in.	0.390 in.	0.014 in.
2 x 3.5 inches double cut	0.25 in.	0.291 in.	0.209 in.	0.014 in.

- ◆ In the "Adding" mode, the BC-10 stops when it runs out of sheets.
- ◆ In the "Preset" mode, the machine stops when the "Preset" numbers of sheets are finished. And two seconds later, the "Preset" number appears again in the Display. Press the Start button again to repeat the same job.
- ◆ To stop cutting, press the Stop button. The "Stop" LED turns on and the BC-10 stops after cutting the current sheet. Do not press the Start button until the machine stops.

6.11 Move the Slitter Unit to adjust the side margin.

1. Loosen the Slitter Unit Adjusting Screws.
2. Using the Slitter Unit Adjusting Gauge (located on the Slitter Unit), slide the Slitter Unit the necessary amount. The Slitter Unit can be moved about .08 inches or 2 mm from center.
3. Tighten the screws up after an adjustment.

 **CAUTION:** Never disassemble the Cutter Unit or the Slitter Unit. Serious injury could result.

6.12 Emergency stop and safety features

The Upper Cover and the Trash Box are electrically interlocked with the machine so that the BC-10 stops immediately whenever either one of them is opened or pulled out.

- ◆ For emergency stops, open the Upper Cover or pull out the Trash Box.
- ◆ To restart the machine, ①close the Upper Cover or insert the Trash Box completely, ②remove any jammed sheets, and ③press the Start button.

The machine will not restart unless the Upper Cover is closed and the Trash Box is returned.

6.13 To fix paper jams

 **CAUTION:** Be sure to turn off the Power Switch before removing the jammed paper to avoid the risk of electric shock.

- ◆ Opening the Upper Cover stops the machine in the middle of an operation. Open the Upper Cover to remove the jammed paper completely.
- ◆ "E002" appears in the Display. This indicates the Cutter Unit stopped in the middle of cutting. Open the Upper Cover. If a sheet is jammed between the blades, close the Upper Cover and turn the Power on. Press the Ready button to open the Cutter Blades. Turn the Power off and open the Upper Cover to remove the sheet.

 **DANGER:** After opening the Cutter Blades, turn off the Power Switch to avoid the risk of electric shock. Confirm the power is off and remove the jammed paper.

- ◆ "E006" means the S2 sensor cannot read the lead edge of a sheet. Lift up the Paper Feeder Unit to remove the sheet. The sensor cannot read highly transparent or dark paper. Curls or waves on paper can also cause feeding problems. In this case, it is necessary to straighten the paper. Be sure to put the Paper Feeder Unit back to its regular position.
- ◆ "E007" indicates a sheet did not reach the S3 sensor in time. Detach the Pressure Roller Unit to remove the jammed sheet. Be sure to put the Pressure Roller Unit back to its regular position.

6.14 Over time paper fragments will accumulate in the Trash Box.

Be sure to empty the Trash Box periodically. Overflowing fragments can cause paper jams.

⚠ CAUTION: Do not put your hands in the Slitter Unit if the Trash Box has been pulled out. Serious injury may result.

6.15 Always turn off the Power Switch when finished.

⚠ DANGER: If you notice a strange sound or smell while the BC-10 is running, turn off the Power Switch immediately and remove the plug. Call the supplier for repair.

7. MAINTENANCE

7.1 To replace the Pick-up Roller:

1. Remove the Setscrew and pull out the Roller.
2. Put a new Roller on the shaft. Make sure the Roller is set in the proper direction. The Roller has a one-way clutch so that it will not rotate in the wrong direction.
3. Tighten the Setscrew.

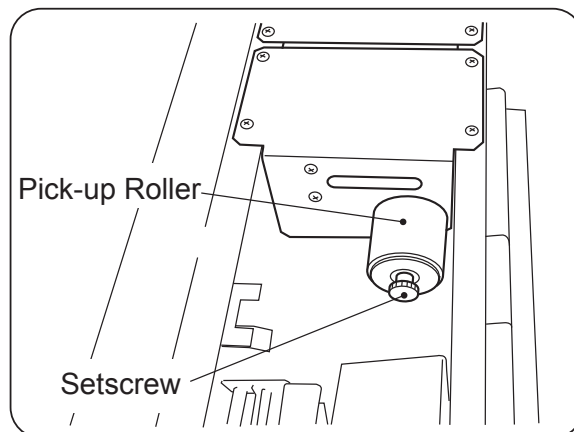

7.2 If the cut edges have gotten dull, it is necessary to replace the blades.

- ◆ If the long sides of finished cards are not crisp, the Cutter Unit must be replaced.
- ◆ If the short sides of finished cards are not crisp, the Slitter Unit must be replaced.
- ◆ Call the supplier for replacement.

 **CAUTION:** Never disassemble the Cutter Unit or the Slitter Unit. Serious injury could result.

Take care not to feed staples or clips into the BC-10 — they will damage the blades.

7.3 Do not touch the Mainboard under the Front Cover.

7.4 The BC-10 does not require oiling.

7.5 When cleaning, do not use alcohol or any solvents. They can harm plastics and painted surfaces.

 **CAUTION:** Do not remove the transparent cover of the trash box. It is part of the safety cover of the Slitter Unit, which protects operator's hands while the Card Stacking Box has been removed.

8. OPTIONAL PARTS

8.1 Slitter Unit

- ◆ The BC-10 has 5 cutting modes:
 - A. 3 modes for A4-sized paper
 - B. 2 modes for Letter-sized paper (See **4.2**)
- ◆ When one of 3 modes (A) is selected, the width of the card is 90mm.
- ◆ When one of 2 modes (B) is selected, the width of the card is 3.5 inches (89mm).

Two types of Slitter Units are available for the BC-10. If a customer selected a Slitter Unit for Letter-sized paper, an A4 Slitter Unit is optional. The Slitter Units are motorized for easy installation.

9. TROUBLESHOOTING

Troubles	Possible Cause	Action
1. The Display and LEDs do not light up when you turn on the Power Switch.*	The Power Cord is not properly connected to an outlet and the Power Inlet.	Connect the Power Cord properly to an outlet and the Power Inlet.
	The Outlet is dead.	Make sure the outlet is alive.
2. The BC-10 does not work when you press the Start button.*	There is an error code in the Display.	Clear the error and restart.
	The "Preset" number is set to "0" with the "Preset" mode being on.	For a test cutting, select "10" as the "Preset" number and try cutting again. Refer to 6.8 .
3. The BC-10 does not start feeding sheets when you press the Start button.*	The sheets are too thick.	Try thinner sheets (under 0.012" or 0.30mm).
	The lead edge of the sheets curls too much.	Straighten the lead edge of the sheets.
	There is some silicone oil on the sheets.	Replace the sheets.
	The friction of the paper is too much.	Try some other paper with less friction.
	The Pick-up Roller has worn out to lose its grip.	Replace the Pick-up Roller.
4. A sheet stops after moving slightly.	The sensor cannot detect because the paper is irregular (highly transparent or too dark).	Use proper papers.
5. Two or more sheets are fed at one time.	The humidity of the atmosphere is so low as to cause electrostatic problems.	Operate the BC-10 under proper conditions. See page 6.
	The sheets get stuck together because of static electricity.	Fan the stack of sheets and reload.
	The BC-10 is not grounded.	Make sure the machine is grounded.
	The Separate Pad is worn out.	Replace the Separate Pad.

Troubles	Possible Cause	Action
6. The BC-10 stops in the middle of cutting and "E002" appears in the Display (repeatedly).	The Cutter blades have got damaged and got partly dull because something hard such as a clip or a staple was cut.	Replace the Cutter Unit.
7. The cut edges are not crisp.	The Cutter blades have worn out. (When the long sides of finished cards are not crisp.)	Replace the Cutter Unit.
	The Slitter discs have worn out. (When the short sides of finished cards are not crisp.)	Replace the Slitter Unit.
8. The lengths of finished cards are unequal (more than 0.15mm).	The paper curls or waves too much to be conveyed smoothly.	Remove the paper from the Paper Feeder Tray and straighten it.
	The paper has so much friction that it cannot be conveyed properly.	Try some other papers with less friction.
9. Cutting accuracy is good, but the positions of printed images are uneven.	The layout is not good.	Redo the layout.
10. The Display does not operate correctly.	The BC-10 is out of order.	Call for service.
11. Finished cards do not accumulate neatly in the Card Stacking Box or cut fragments get scattered in the Trash box.	The BC-10 is not grounded and affected by static electricity.	Make sure the machine is grounded.
	The atmosphere is too dry and static electricity affects.	Check the humidity and try a humidifier if needed.

Troubles	Possible Cause	Action
12. With the cutting mode set to "double cut," cut fragments go forward and cause fouling.	The atmosphere is too dry and static electricity affects.	Try a humidifier to make the atmosphere more humid than 50%.
	The BC-10 is not grounded and affected by static electricity.	Make sure the machine is grounded.
13. The BC-10 does not respond to command inputs.*	The Onboard Microcomputer has been affected by an electromagnetic noise.	Turn off the Power Switch. Wait seven seconds and turn the power back on. This procedure resets the microcomputer.

***1, 2, 3, 13:** If all of the items in each section have been checked and the problems are still unresolved, the BC-10 needs to be repaired.

If problems continue after checking all the items above, call for service.