

MARLON 350A AUTO CRIMPER



OPERATORS MANUAL

INTRODUCTION

Your new Marlon 350 Auto Crimper is designed to increase your plastic spiral binding production. The Marlon 350 is an inexpensive yet extremely versatile tabletop machine. The Marlon 350 cuts and crimps 6mm through 50mm coil, with an adjustable binding length from 3.5-inches to 14-inches. The Marlon 350 is capable of 50 cycles per minute, and features a coil waste chute that uses standard plastic grocery bags for clipping waste containment. The Marlon 350 is an operator friendly machine that is easy to set up, allowing for quick changeover from one coil diameter to another. We are confident that your new Marlon 350 Auto Crimper will be a valuable asset to your plastic coil binding operation.

The following pages of this manual will cover machine setup, operating procedures, and trouble shooting your Marlon 350 Auto Crimper.

MARLON 350 AIR CONNECTIONS

QUICK CONNECT ADAPTER PICTURED IS NOT INCLUDED WITH MACHINE.

USE A SIMILAR ADAPTER THAT MATCHES YOUR AIR SUPPLY.

MAIN AIR INPUT ¼" NPT BULKHEAD FITTING

120 P.S.I. MAXIMUM AIR PRESSURE

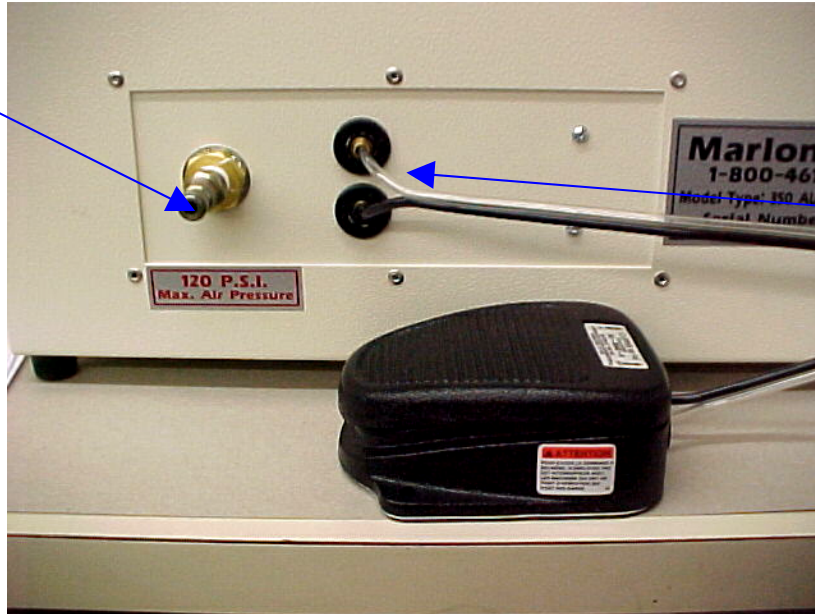

CONNECT THE FOOT SWITCH TO THE CRIMPER BY INSERTING THE CLEAR TUBE INTO THE TOP PUSH LOCK FITTING AND THE BLACK TUBE INTO THE BOTTOM PUSH LOCK FITTING

COIL WASTE CHUTE



PLACE BAG HANDLES IN THESE SLOTS TO HOLD BAG

THE COIL WASTE CHUTE USES STANDARD PLASTIC GROCERY BAGS FOR CLIPPING CONTAINMENT. PLACE THE HANDLES OF THE BAG IN THE SLOTS ON BOTH SIDES TO HOLD THE BAG IN PLACE.

BLADE SELECTION

The Marlon 350 Auto Crimper features interchangeable cutter blades. Your Marlon 350 is shipped with the B-size cutter blades installed. Use the following chart to determine what blade size is required for the coil diameter your crimping.

A-size blades: 6mm and 7mm coil

Note: Over sized punch patterns (.248) or punch patterns with a large backstop (distance from paper edge to hole) will not work well with the A – size cutter head.

B-size blades: 8mm through 25mm coil

C-size blades: 12mm through 50mm coil

The cutter blades and cutter head assemblies have been color coded to reduce the chance of improper assembly.

- 1.) **Universal parts** of the cutter head assembly that are used for all three sets of knives are **marked white**. These parts are used all of the time.
- 2.) **A-size parts** of the cutter assembly are **marked red**.
- 3.) **B-size parts** of the cutter assembly are **marked green**.
- 4.) **C-size parts** of the cutter assembly are **marked yellow**.

Note: Some parts of the cutter assembly are marked with two colors. These parts are used on two of the three cutter assembly configurations.

CUTTER HEAD ASSEMBLY

Air Cylinder

Clamp blade spring

Clevis

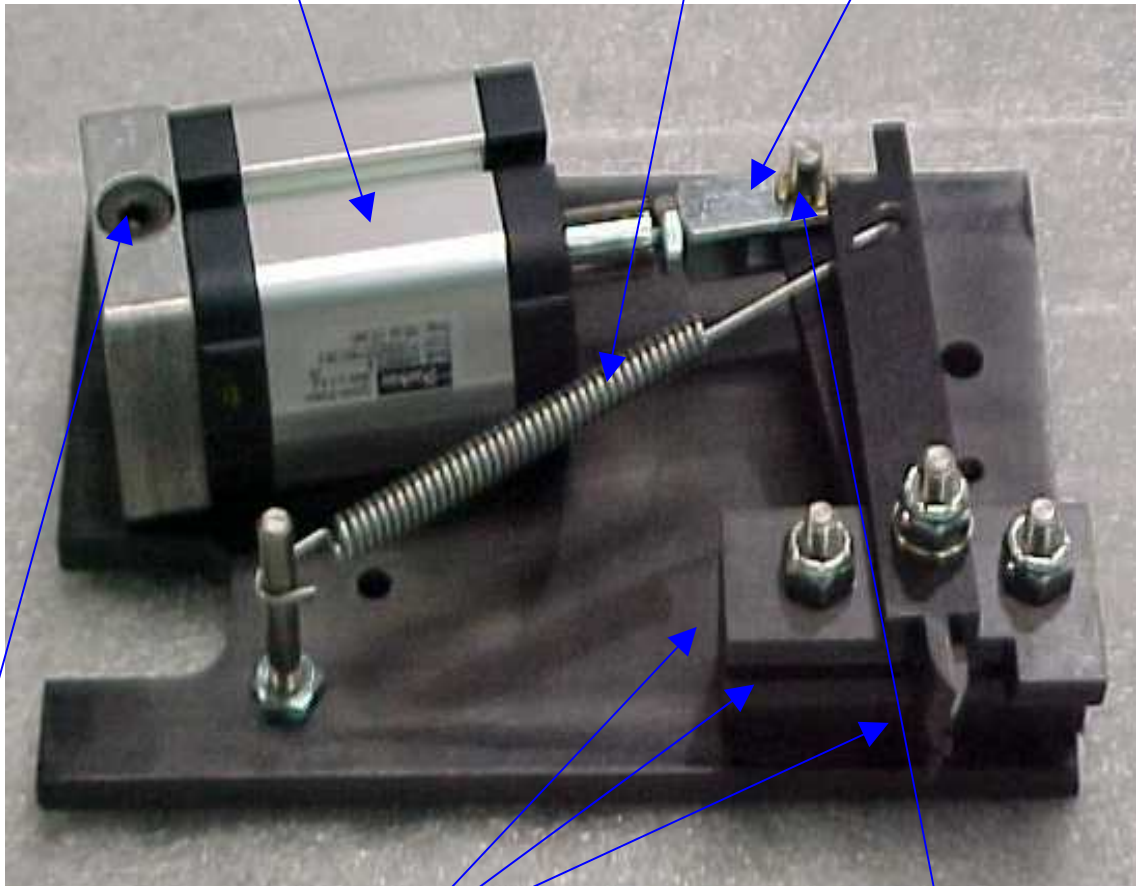

Cutter blade assembly

Clevis Pin

Air cylinder mounting bolt

B-SIZE CUTTER BLADE ASSEMBLY

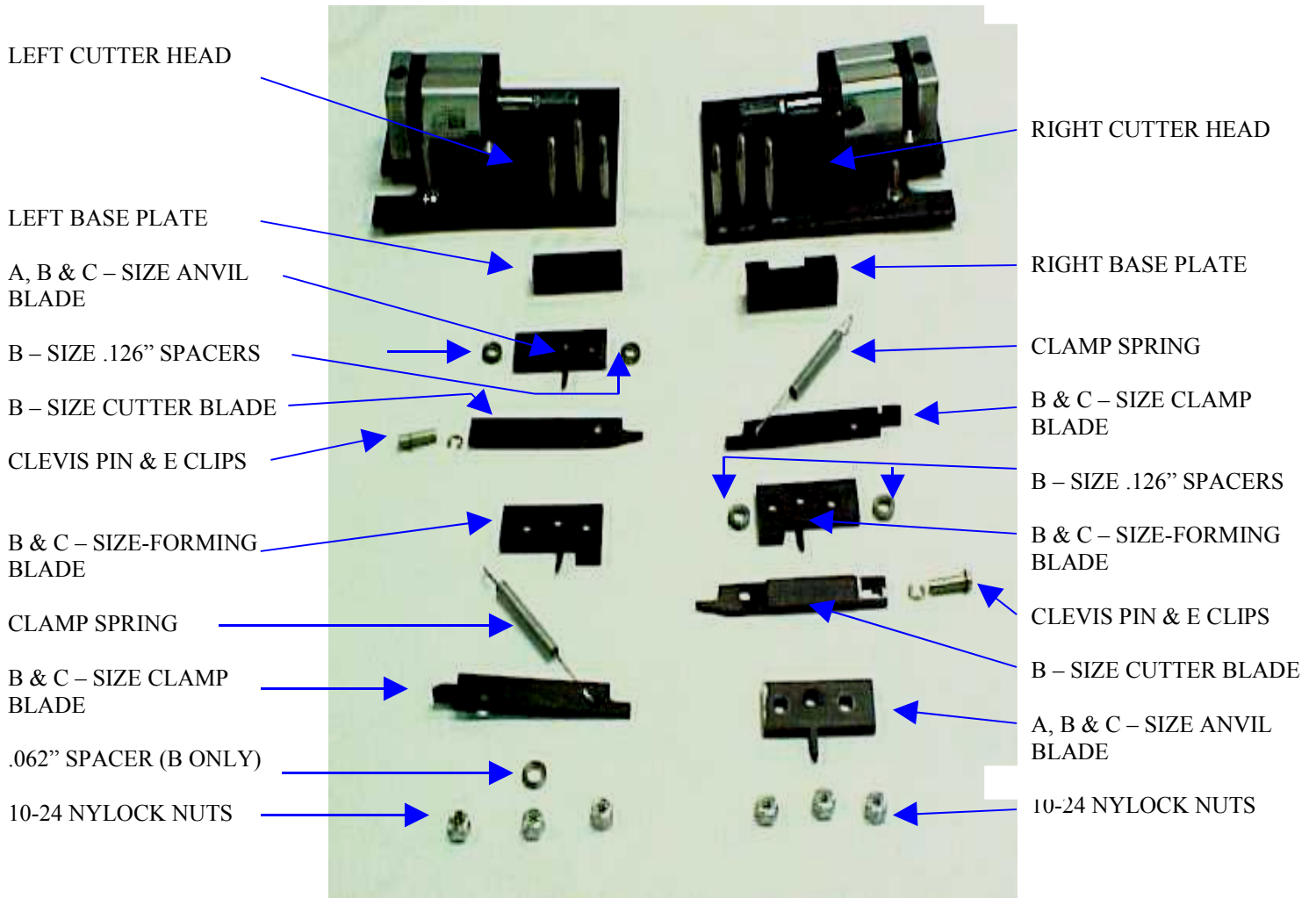

NOTE: THE RIGHT CUTTER BLADE ASSEMBLY IS UP SIDE DOWN. THE SAME FOUR BLADES ARE USED ON BOTH SIDES, BUT THEY ARE INSTALLED IN EXACTLY THE OPPOSITE ORDER.

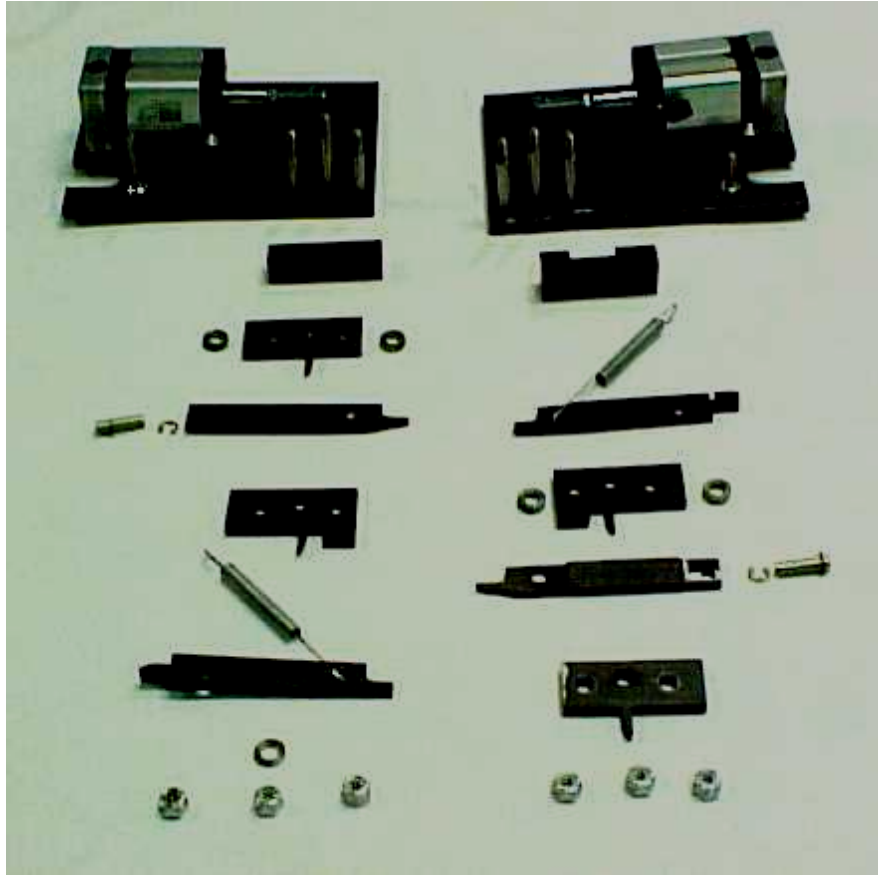

Pictured above is the B-size cutter blade assembly.

The following information describes the changes needed to switch from the B to A-size and B to C-size cutter assemblies. Refer to the color codes on page four to select the proper parts when changing from one blade configuration to another. Refer to pages five and six for part descriptions.

Changing from B to A-size blades:

- 1.) *Disconnect the air supply from Marlon 350.*
- 2.) *Remove the top cover from the machine.*
- 3.) *Unhook the springs from the studs on both sides.*
- 4.) *Remove the three 10-24 nylock nuts from each side.*
- 5.) *The left clamp blade is now free.*
- 6.) *Remove the right anvil blade by lifting it straight up.*
- 7.) *Remove the left forming blade by lifting it straight up.*
- 8.) *Detach the right cutter blade from the clevis. (Use a straight blade screwdriver to pry the top E clip off of the clevis pin. Slide the clevis pin out of the clevis; the right cutter blade is now free.)*
- 9.) *Remove the three .126" B-size spacers from each side.*
- 10.) *Remove the right forming blade by lifting it straight up. The right clamp blade is now free.*
- 11.) *Detach the left cutter blade from the clevis. (See step 8 for details.)*
- 12.) *Leave the left anvil blade on, because it's used in all three setups.*
- 13.) *Reassemble the cutter blade assemblies in reverse order using the correct color-coded parts.*
- 14.) *Use the fifth .094" A-size spacer instead of the .062" spacer on the left hand center stud.*

A-KIT COIL GUIDE INSTALLATION

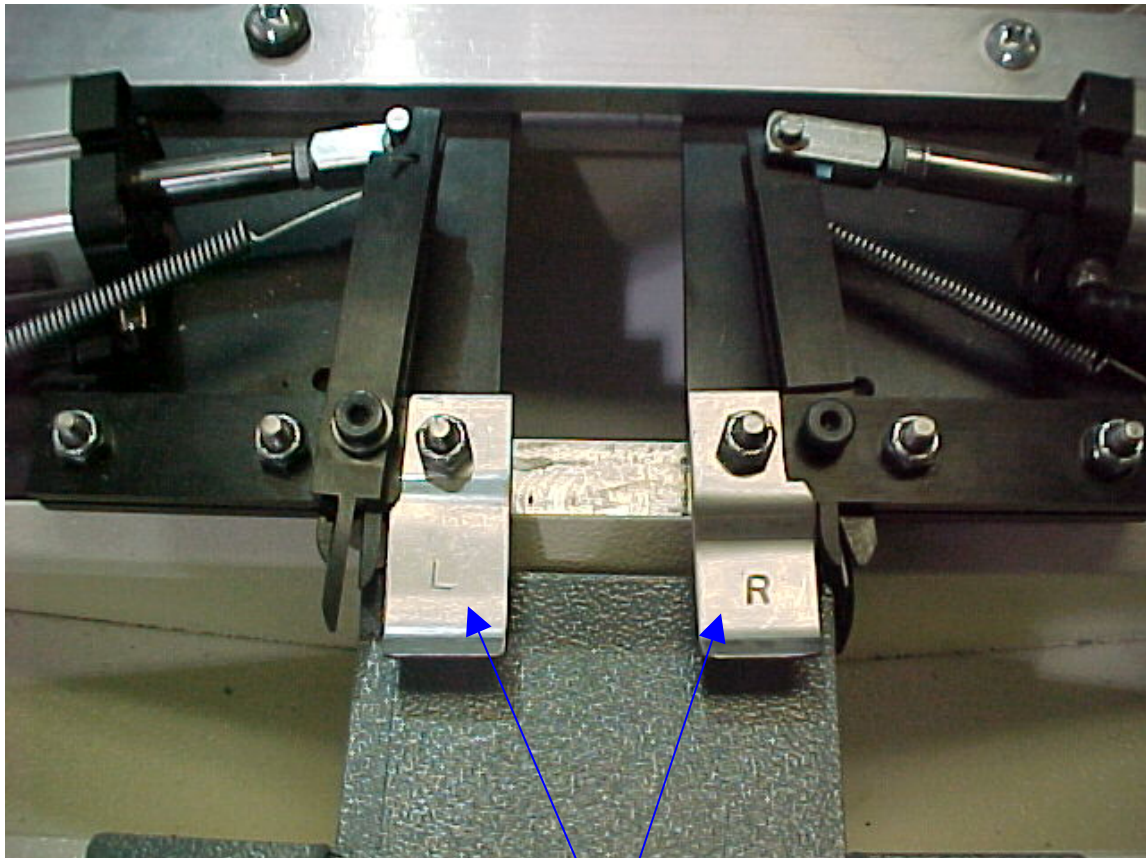

PICTURED ABOVE ARE THE COIL GUIDES INSTALLED ON THE CUTTER ASSEMBLY. THESE GUIDES ARE ONLY USED WITH THE A-SIZE BLADE CONFIGURATION. THE COIL GUIDES ARE STAMPED "L" FOR LEFT AND "R" FOR RIGHT AND ARE ALWAYS INSTALLED WITH THE LETTERS UP. YOU HAVE TWO "L" GUIDES ONE MARKED "L" AND ONE MARKED "L 6". THE "L 6" IS USED FOR 6mm DIA. COILS ONLY.

CHANGING FROM “B” to “C” size blades

- 1.) *Disconnect the air supply from Marlon 350.*
- 2.) *Remove top cover from machine.*
- 3.) *Unhook the springs from the studs on both sides.*
- 4.) *Remove the three 10-24 nylock nuts from each side.*
- 5.) *The left clamp blade is now free.*
- 6.) *Remove the right anvil blade by lifting it straight up.*
- 7.) *Remove the left forming blade by lifting it straight up.*
- 8.) *Detach the right cutter blade from the clevis. (Use a straight blade screwdriver to pry the top E clip off of the clevis pin. Slide the clevis pin out of the clevis; the right cutter blade is now free.)*
- 9.) *Remove the two 126” B-size spacers from each side.*
- 10.) *Remove the right forming blade by lifting it straight up. The right clamp blade is now free.*
- 11.) *Detach the left cutter blade from the clevis. (See step 8 for details.)*
- 12.) *Leave the left anvil blade on, because it’s used in all three setups.*
- 13.) *Change the air cylinder position on both sides by unscrewing the air cylinder mounting bolt (shown on page 5) now move the air cylinder to it’s correct hole position and tighten the air cylinder mounting bolt. (See picture on page 10 for details.)*
- 14.) *Reassemble the cutter blade assemblies in reverse order using the correct color-coded parts.*
- 15.) **Note:** *No spacer is used on the left-hand center stud when using the C-size blade configuration.*

C-CUTTER BLADE INSTALLATION

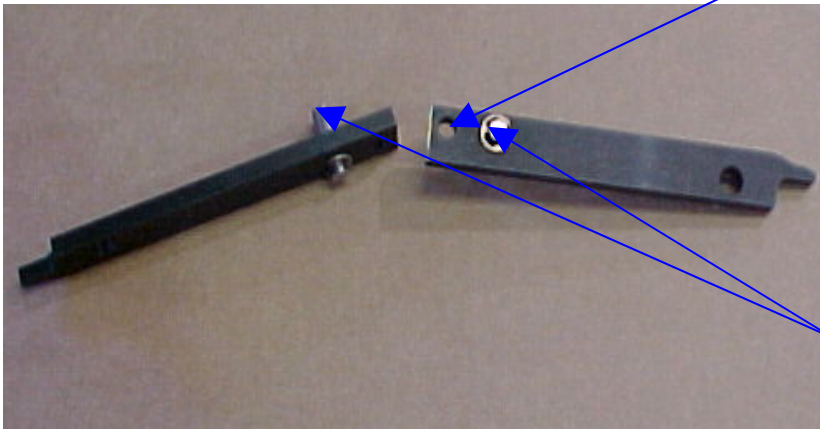

CONNECT THE AIR CYLINDER TO THE HOLE AT THE REAR OF C-CUT BLADES.

THE TWO CLEVIS PINS INSTALLED ON THESE BLADES ARE USED TO ACTIVATE THE CLAMP BLADES.

PICTURED ABOVE ARE THE C-SIZE CUTTER BLADES. THE CLEVIS PINS INSTALLED ON THE C-CUTTER BLADES ARE NEEDED TO PUSH THE CLAMP BLADES. DO NOT CONNECT THE AIR CYLINDERS TO THESE PINS. THE AIR CYLINDER SHOULD BE CONNECTED TO THE C-CUTTER BLADES USING THE OPEN HOLE AT THE REAR OF THE BLADE. THE CLEVIS PIN USED TO DRIVE THESE BLADES IS IN THE AIR CYLINDER CLEVIS. THE C-KIT FURNISHED WITH YOUR MACHINE HAS THE PINS INSTALLED CORRECTLY.

AIR CYLINDER MOUNTING POSITIONS

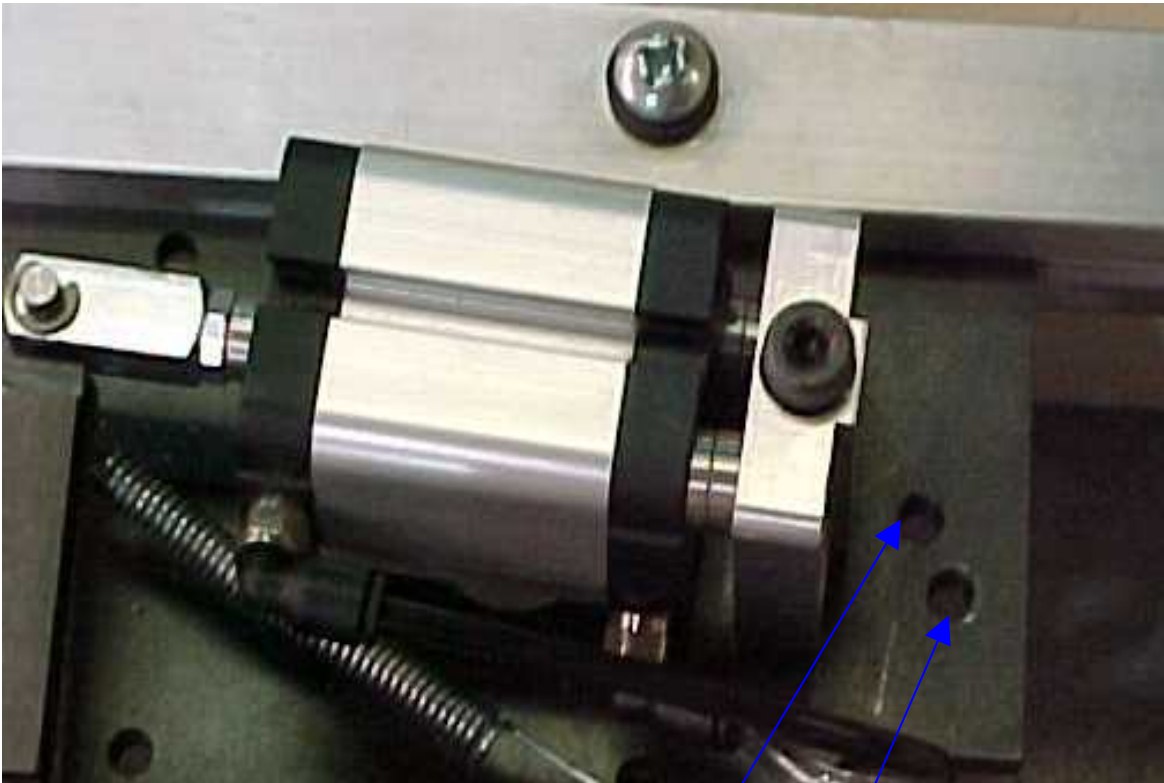

*Mount the air cylinders in the top inside holes
for C-size blade configuration.*

*Mount the air cylinders in the bottom outside holes
for A and B-size blade configurations.*

TABLE ADJUSTMENTS

Now that you have the correct blade configuration ready for the coil diameter you are crimping you need to adjust the table height and cutter head spacing (width) for your book. Refer to page 13 for table adjustment details.

- 1.) Loosen the two clamp knobs on the left-hand book guide; position the guide so your book will be approximately centered on the machine. Re tighten the two clamp knobs.*
- 2.) Using the same procedure position the right-hand book guide so it just touches the right edge of the book. The book should lay flat on the table between the book guides and be able to slide in and out, but not side to side.*
- 3.) Use a #3 Phillips screwdriver to loosen the two bolts located under the two access holes in the top cover. The two cutter heads will now be able to slide from side to side. Slide the two cutter heads so the cutter blades are close to the correct loop of the coil at each end of the book.*
- 4.) Make a rough adjustment on the table height by turning the two table height knobs. Turn the knobs clock-wise to lower the table and counter clock-wise to raise the table. Adjust the table height so the coil in the book is in the center of the cutter blade assembly on both sides. The right side of the table will always be adjusted higher than the left side.*
- 5.) Adjust the two cutter heads from side to side until the coil in the book slides into the cutter blades at the correct loop of the coil on each side of the book. **Note:** The air must be plugged into the machine at this time so the cutter blade assembly is open.*
- 6.) Make a finer adjustment to the table height so the coil in the book is properly positioned in the center of the cutter blades.*
- 7.) Make your final cutter head adjustments side to side if needed and then re tighten the two bolts under the access holes of the top cover using the #3 Phillips screwdriver.*
- 8.) Test crimp a book by depressing the foot pedal.*
- 9.) Make your final table height adjustments if needed. Then repeat steps #8 and #9 until the desired crimp is achieved.*

TABLE ADJUSTMENT DETAILS

TWO ACCESS HOLES
IN TOP COVER

TABLE HEIGHT
ADJUSTER KNOBS:
ONE ON EACH SIDE

BOOK GUIDES: ONE ON
EACH SIDE

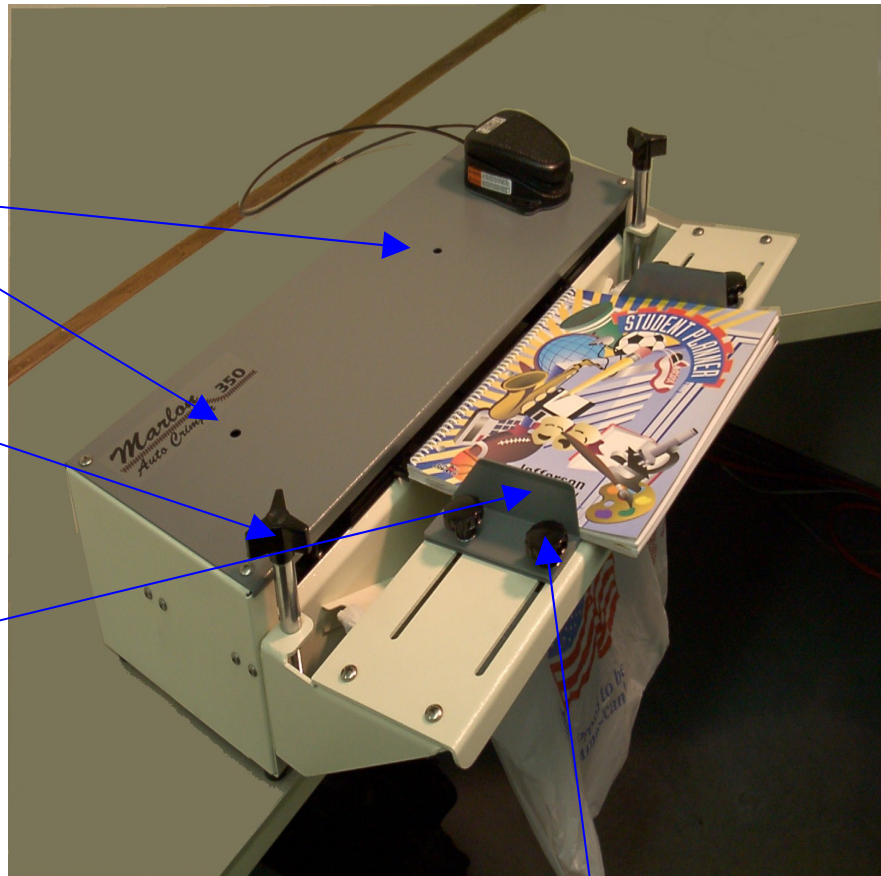

CLAMP KNOBS: TWO ON EACH BOOK GUIDE

MARLON 350A AUTO CRIMPER

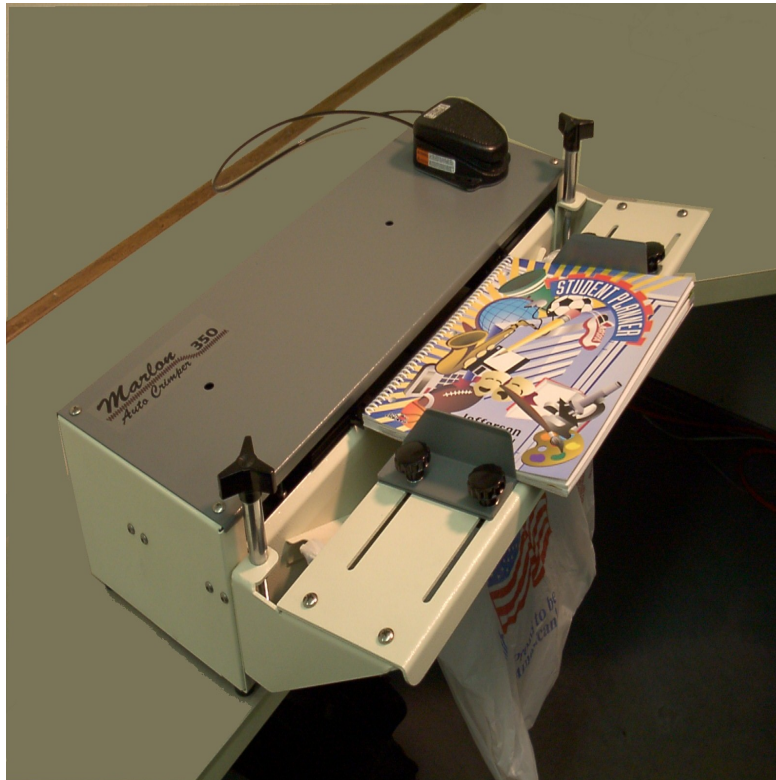

MARLON INC.
123 EAST 45TH STREET
BOISE, IDAHO 83714
Ph (800) 461-9301
Fax (208) 321-2796