

OPERATING INSTRUCTIONS

FINISHER 4300

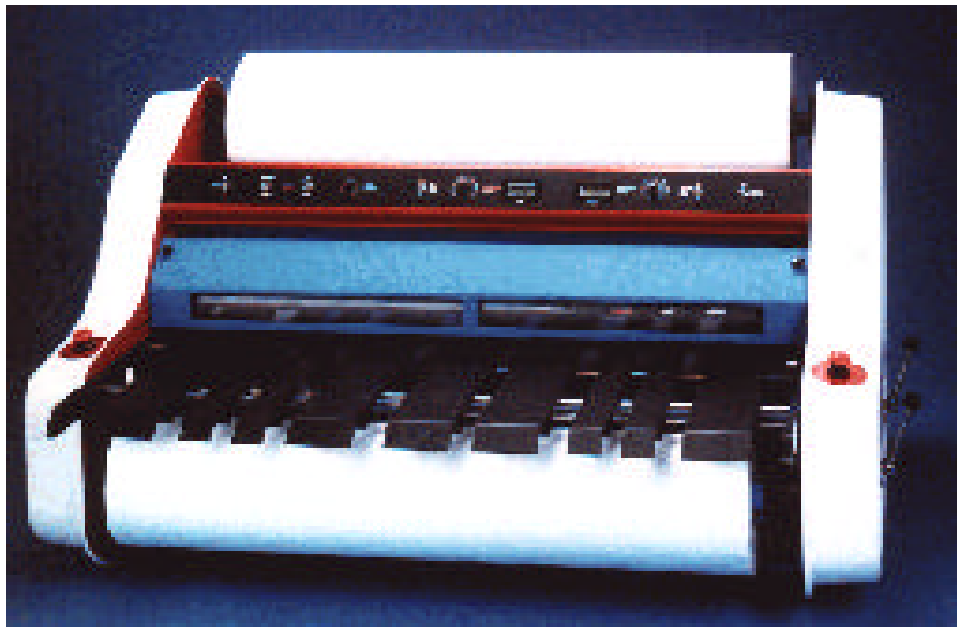

Model No. BA-FS43

Banner American Products, Inc.
Temecula, CA

Table of Contents

I.	For Your Safety	2
II.	Electrical Safeguards	2-3
III.	Specifications	3
IV.	Set-up	3-5
	Inspection	3
	Appropriate Location	3
	Loading Film onto Mandrels	3
	Threading the Film	4
	Mandrel Tension Adjustment	4
	Roller Pressure Adjustment	4
	Slitters	5
V.	Thermal Laminating	5
VI.	Pressure Sensitive Laminating	6
VII.	Coating Mount Board	6
VIII.	Mounting & Laminating	7
IX.	Maintenance/Service	7-8
	Cleaning Rubber Rollers	8
	Cleaning Heat Shoes	8
	Removing Wrap-arounds	8
X.	Trouble-shooting	9
XI.	Laminating & Mounting Do's & Don'ts	10
XII.	Warranty & Return Policy	10

Finisher 4300 (BA-FS43)

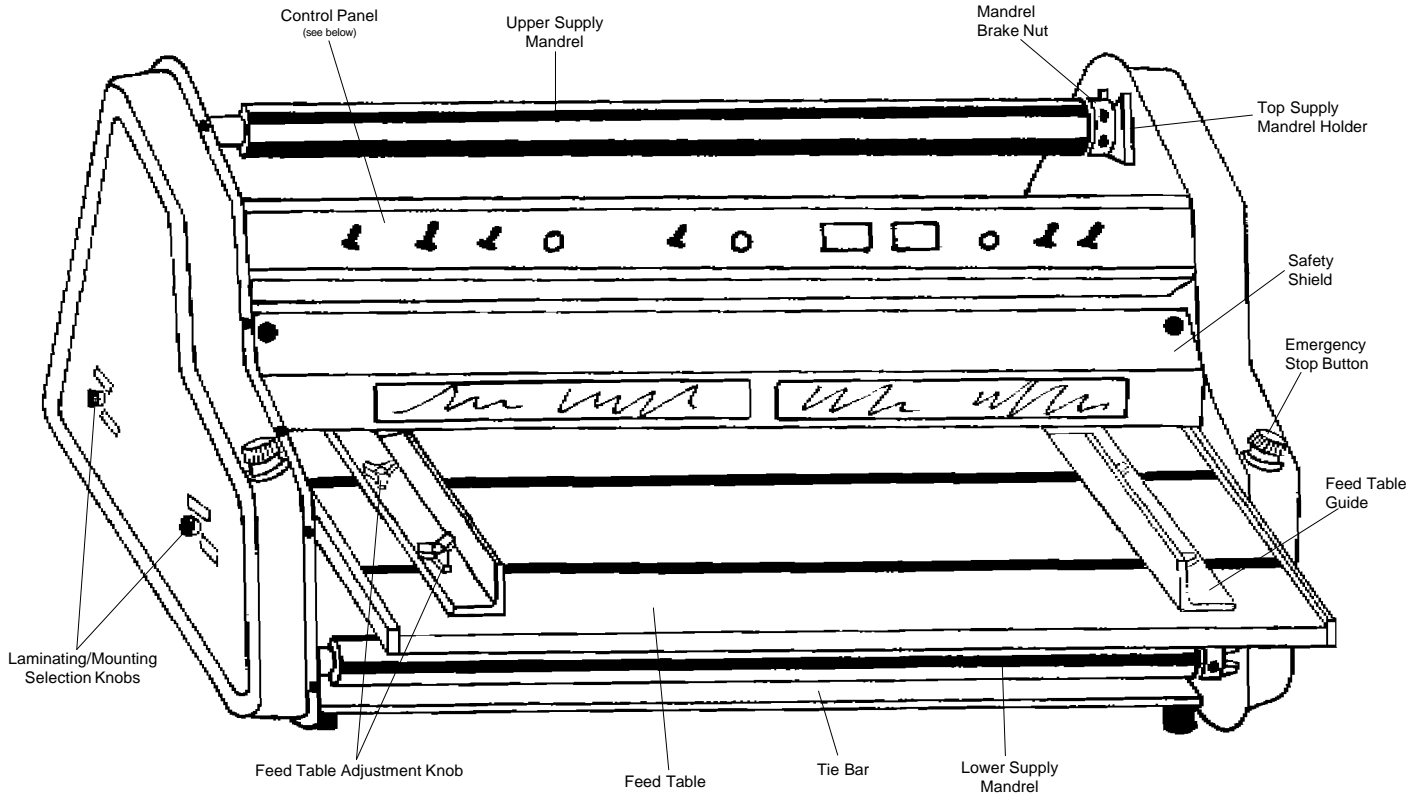

Left Side Cover

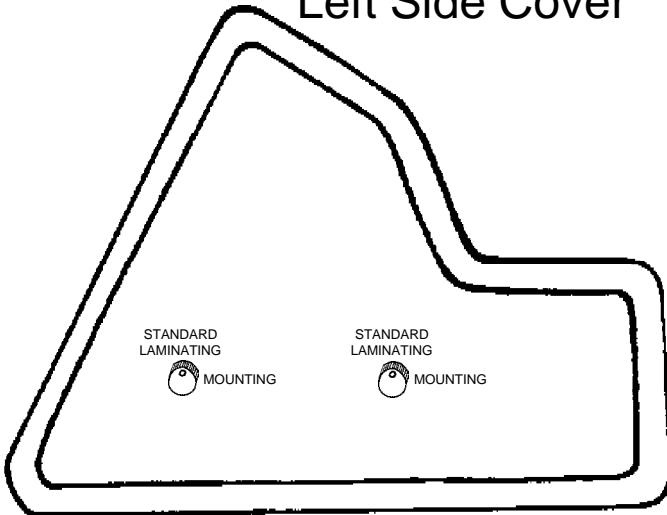

Right Side Cover

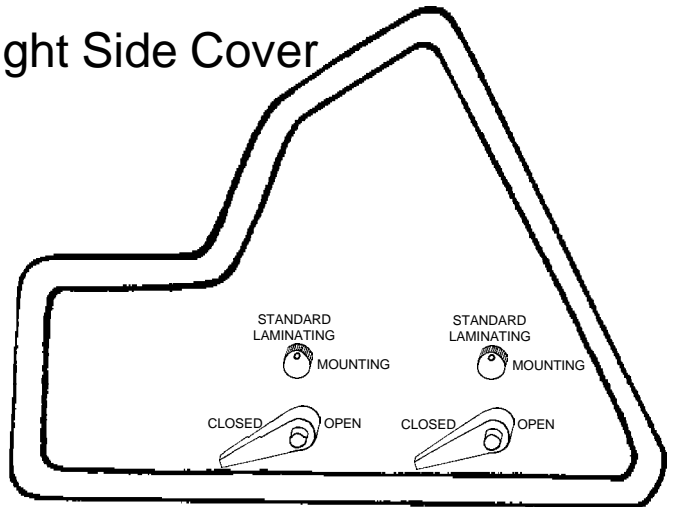

Control Panel

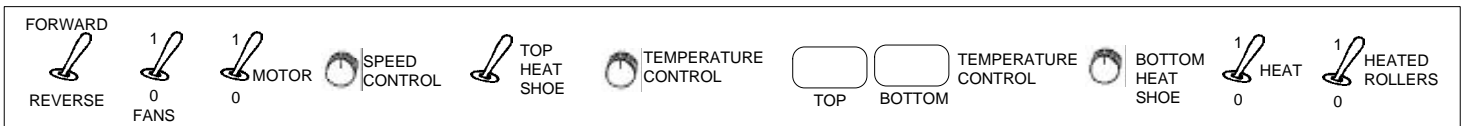

Mandrel



I. For your safety...

- ◆ Do not connect the laminator to electrical power or attempt to operate it until you have read these instructions completely. Keep these instructions in a convenient location for future reference.
- ◆ Read all safety messages located in this instruction manual and on the laminator very carefully.
- ◆ Always replace safety shield before operating your laminator. If you service this machine yourself, ensure that the safety shield is returned to the operating position when service is completed. Do this to protect all operators. Operators may be harmed if you do not follow this instruction.
- ◆ Use caution when removing the feed table as it weighs approximately 34 lbs. Removing feed table exposes hot and moving parts. This means that you can be harmed if you remove the feed table. When the table is in the proper position the risk of injury to the operator is reduced.
- ◆ Do not operate this laminator without all detachable units installed correctly. This means that there is risk of injury if this product is operated without all of its parts in their proper positions.
- ◆ Keep hands and clothing away from rollers. The rollers are pinch points that can trap body parts or clothing and cause serious injury.
- ◆ Do not touch the heat shoes or front rollers while the laminator heater power is on. Turn rollers and shoes off allow to cool.
- ◆ Do not use the laminator for other than its intended purpose.
- ◆ Only operate this machine if you have been properly trained and authorized to do so. Contact the manufacturer for training information at 909-296-9780.

II. Electrical Safeguards...

- ◆ Never override or attempt to defeat electrical or mechanical safety interlock devices.
- ◆ Disconnect power supply before servicing your laminator. This laminator uses *double pole/neutral fusing*.
- ◆ A readily accessible disconnect device should be incorporated in the fixed wiring.
- ◆ The machine has been manufactured without a plug on the power cord. We recommend that you connect this unit directly to a power main. Have a qualified electrician install your power supply for you. Care must be exercised to properly identify the neutral wire in the power cord. The neutral power cord wire is color coded white. The neutral of the power main should be identified using a suitable voltmeter.
- ◆ The laminator should only be operated from the type of power source indicated in these OPERATING INSTRUCTIONS and on the serial label located on the rear panel of the unit.
- ◆ Do not leave the laminator power on for extended periods while not in use. Open the panel breaker at the end of the day as a precaution against a possible fire hazard.

- ◆ Do not operate the laminator with a damaged power supply cord or plug.
- ◆ Replace fuses only with same type rated 30A, 240V and 1A, 250V fuses. Contact your dealer for replacement fuses.
- ◆ There are four (4) EMERGENCY STOP buttons on your Finisher 4300, two in the front and two in the back. Depressing any one of these buttons will stop the rollers.



III. Specifications...

Operating Speed:	Adjustable to 20 fpm (10.16cm/sec.)
Power Requirements	
Voltage:	Single Phase 208-240 VAC, 50/60 hz
Warm Up Time:	10 minutes
Fuse:	30 A
Maximum Laminating Dimensions	
Thickness:	½" (12.70mm)
Width Capacity:	43" (1092mm)
Net Weight:	370 lbs (136.2 kgs.)
Shipping Weight:	700 lbs (272 kgs.)



IV. Set-up...

Inspection:

Upon receipt of your Finisher 4300, inspect the crate, the machine and all other contents of the crate for shipping damage. Damage should be brought to the immediate attention of the delivering carrier.

Appropriate Location:

Your Finisher 4300 must be placed on a sturdy table or stand in a clean, well lit area with ample space on all four sides of the laminator. Contact your dealer for the optional stand designed especially for the Finisher 4300.

Loading Film onto Mandrels

The following instructions apply to poly-in film rolls.

Top Roll: With the brake nut to the right, pull the core gripper blade toward you and place the roll of film onto the mandrel so that the film unwinds toward you from the bottom of the roll. Turn the roll on the mandrel to lock the core gripper blade into the cardboard film core.



Bottom Roll: With the brake nut to the right, push the core gripper blade away from you and place the roll of film onto the mandrel so that the film unwinds toward you from the top of the roll. Turn the roll on the mandrel to lock the core gripper blade into the cardboard film core.



The core gripper blades on the top and bottom mandrels spring back in opposite directions. The blade should spring back in the direction that the core will rotate when laminating. When the film is loaded properly the core gripper blade will prevent the film from turning on the mandrel. To determine top and bottom mandrels, with the brake nut on the right, the core gripper of the top mandrel will spring away from you. When using *poly-in* rolls the top roll of film should unwind from the bottom and the bottom roll should unwind from the top. With *poly-out* rolls the top roll will unwind from the top and the bottom roll from the bottom. Once the film is properly loaded onto the mandrels, replace the mandrels onto the laminator.

Threading the Film (Figures 1&2)

1. Feed the film from the top roll behind the upper idler roller rod and lay it over both heat shoes. Be sure that the adhesive side of the film is facing out and the non-adhesive side is against the heat shoes.
2. To thread the lower roll, first remove the two red knobs on each side of the idler slide mechanism. Slide the idler mechanism toward you.
3. Pull about 4' of film from the bottom roll. Feed the film from the bottom roll under and behind the lower idler roller rod. Push the idler slide mechanism back into position and return the red knobs.
4. Lay the film from the lower roll over the film from the top roll and both heat shoes, again ensuring that the adhesive side of the film is facing away from the heat shoes. If you are cold loading it will be necessary to tape the bottom film to the top film. If you are hot loading, the bottom film will adhere to the top film where it overlaps at the heat shoes.
5. Have a large piece of poster board ready to use as a feed card to thread the film between the rollers and through the laminator.
6. Open the ROLLER RELEASE handle and set the PRESSURE ADJUSTMENT knob on both sides of the laminator to the LAMINATING position. Close the rollers.
7. Set the FORWARD/REVERSE switch to the FORWARD position and turn the MOTOR ON/OFF switch to the ON position.
8. Turn the SPEED CONTROL knob far enough to allow the rollers to sufficiently pull the poster board into the laminator. Keep in mind that varying films, media, and temperatures will require different speeds.
9. Feed the poster board between the heat shoes and into the front rollers.
10. After the laminator is properly threaded and the poster board has exited the rear of the laminator, make any necessary adjustments.

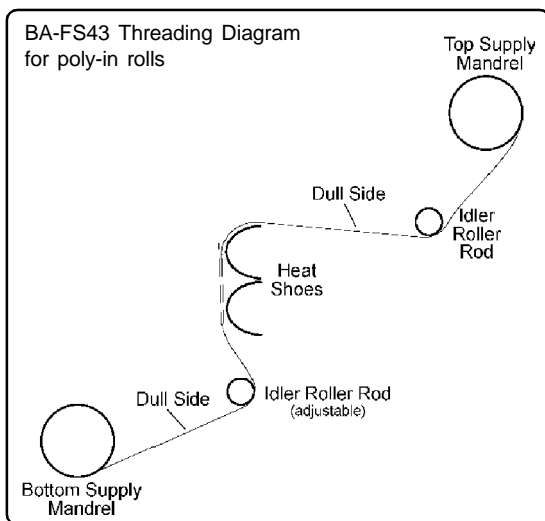

Figure 1

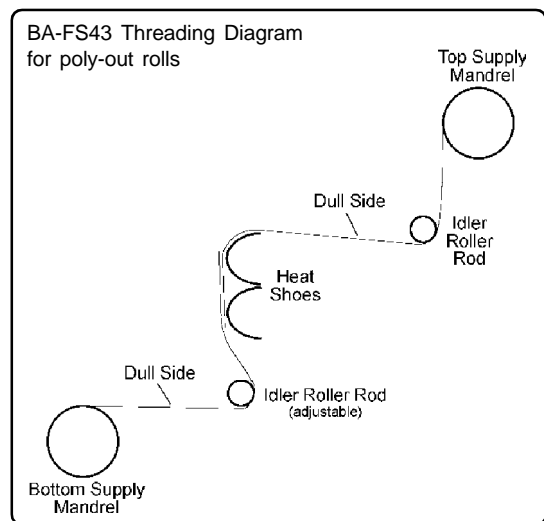

Figure 2

Mandrel Tension Adjustment:

Mandrel tension must be set correctly to ensure good lamination quality. Adjust the tension by turning the brake nut at the end of each mandrel.

To increase the tension, turn the brake nut clockwise. To decrease the tension, turn the brake nut counter-clockwise. Adjust only 1/8 of a turn between tests. Use the minimum amount of tension necessary to achieve good results. (See Section VIII Troubleshooting for possible tension adjustment problems).

Roller Pressure Adjustment:

You may adjust the roller pressure by turning the bolts on the pressure adjustment blocks (see Figure 3), which are located on each side of your laminator behind the bottom film roll. Slide the idler bar out to access the blocks and loosen the set screw. To increase pressure, loosen the bottom bolt and tighten the top bolt. Adjust the pressure only 3/4 of a turn between tests. Adjust each pressure block as necessary.

The pressure on your Finisher 4300 has been preset at the factory. However, shipping and handling may necessitate slight pressure adjustment. Once pressure is properly set you should only need to use the MOUNTING/LAMINATING knobs on the sides of your Finisher 4300.

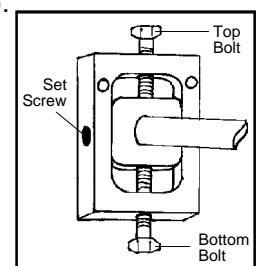
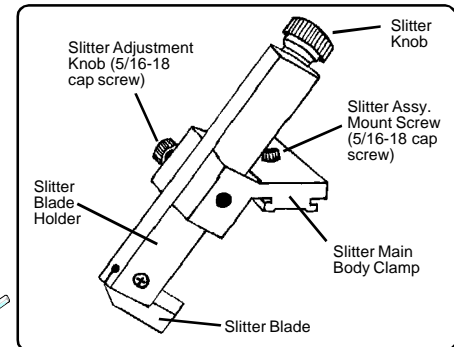
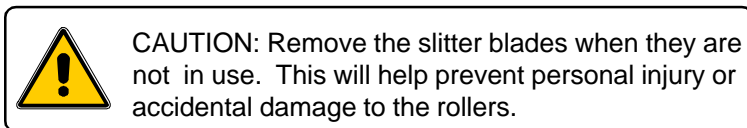

Figure 3

Slitters (Figure 4):

To install the slitters, place the Main Body Clamps into the Top Roller Guard where they will slide into the slots in the in the top edge of the guard located at each end of the guard. Before setting the slitters in place, ensure the machine is loaded with the proper laminating film. Use a piece of paper/card stock the same width as the item to be laminated to feed into the laminator until it has exited several inches beyond the Top Roller Guard. This will permit accurate placement of the slitters. Place the Slitter Blade Holder, blade down, into the mount until the blade barely penetrates the plastic web at the edge of the test piece, leaving the required border beyond the edge. Ensure the point of the blade is pointed toward the front of the laminator. Tighten the Slitter Adjustment Screw on the Main Body Clamp. To ensure the clamp and holder won't move from side to side, use an Allen wrench to tighten the Slitter Adjustment Knob and Slitter Assembly Mount Screw.



V. Thermal Laminating...

1. Be sure all laminator parts (i.e. safety shield, feed table, etc.) are in their proper positions and the laminating film is loaded correctly (See page 3 for film loading instructions).
2. Open the ROLLER RELEASE handle and select the LAMINATING position on both sides of your laminator. Close the rollers.
3. Turn the HEATED ROLLERS and the TEMPERATURE CONTROL switches to the ON positions. The heated rollers are necessary only during warm-up and may be turned off for most applications when operating temperature is reached.

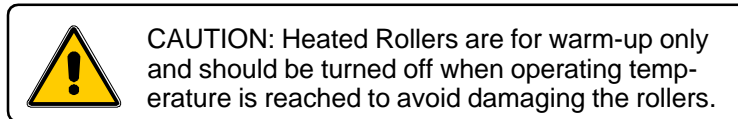

4. Set the temperatures according to the film manufacturer's recommendations for the film you have chosen. A low-melt film is recommended for inkjet prints. Keep in mind that the temperature at which you will laminate will vary with different medias and laminating speeds. See the chart below for approximate temperature ranges. The laminator will take approximately 10 minutes to reach operating temperature. The temperatures will be indicated on the LCD displays on the control panel.

3 mil DIGIKote™	220°-230°F
5 mil DIGIKote™	210°-220°F
10 mil DIGIKote™	180°-190°F

5. Turn the FANS switch ON. This allows for a clear lamination by cooling the film as it exits the rollers.
6. Turn the MOTOR switch ON and perform a test lamination to ensure proper settings for successful lamination. If any adjustments are necessary make them now and run another test. Repeat this step until you obtain desired results.
7. Allow the Finisher to run a small amount of film before feeding the print into the laminator to avoid a dwell line across your print. Feed the print slowly and evenly, smoothing it as the rollers pull it through.
8. You may laminate subsequent prints now, leaving ample space between each print for trimming.
9. Once your last print has completely exited the laminator, turn the MOTOR switch OFF and use the trimmer on the rear of the laminator to remove the laminated prints.

VI. Pressure Sensitive Laminating...

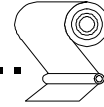

Note: *You must have the Rewind Option for Pressure Sensitive Films in order to laminate with pressure sensitive material.*

1. Load a roll of pressure sensitive film onto the upper mandrel so that it unwinds toward you from the bottom of the roll.
2. Load an empty film core on the take-up mandrel and place it in position in front of the upper mandrel.
3. Either place a roll of material on the lower mandrel that is at least as wide as the pressure sensitive film you are using and thread as usual **or** use an additional piece of media under the print you will be cold laminating. This will keep the adhesive from transferring to the RollerShoes™ or rollers.
4. Thread the pressure sensitive film behind the upper idler roller rod.
5. Peel back enough of the release liner to tape it to the empty film core on the take-up mandrel. Tape the liner to the back of the core and drape the film over both RollerShoes™.
6. Set the PRESSURE CONTROL to the appropriate position (CLOSE for laminating; MOUNT for mounting).
7. Set the FORWARD/REVERSE switch to the FORWARD position.
8. Turn the MOTOR CONTROL ON/OFF switch to the ON position.
9. Turn the MOTOR CONTROL knob far enough to sufficiently pull a feed card into the laminator.
10. Feed the feed card between the RollerShoes™ and into the front rollers.
11. After the laminator is properly threaded and the poster board has exited the rear of the laminator, make any necessary adjustments.

VII. Coating Mount Board...

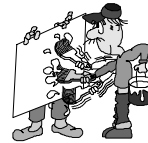

The Finisher 4300 is capable of applying an adhesive coating to mount board that has not previous been coated.

1. Load a roll of adhesive, with the liner wound to the outside, onto the top mandrel in the same manner as with laminating film.
2. Load a roll of paper on the bottom mandrel or use adhesive the same width as the mount board to keep the adhesive from accumulating on the rollers and heat shoes.
3. Open the ROLLER RELEASE handle and select the MOUNT position on both sides of your laminator. Close the rollers.
4. Turn the HEATED ROLLERS and the TEMPERATURE CONTROL switches to the ON positions. The heated rollers are necessary only during warm-up and may be turned off for most applications when operating temperature is reached.
5. Set the temperature to approximately 125°F. The Finisher 4000 will take approximately 10 minutes to reach operating temperature. The roller and shoe temperatures are indicated on the LCD displays on the control panel.
6. Feed the uncoated mount board into the laminator behind a small leader board. The leader board will prevent the compression of the leading edge of your mount board.
7. You may coat subsequent boards now, one directly behind the other, so that the board in front becomes the leader board. We recommend that you coat a sufficient supply of mount board in one session so you'll have it ready for future use.

VIII. Mounting & Laminating...

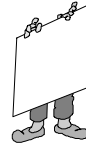

1. Be sure all laminator parts (i.e. safety shield, feed table, etc.) are in their proper positions and the laminating film is loaded correctly (See page 3 for film loading instructions).
2. Open the ROLLER RELEASE handle and select the MOUNT position on both sides of your laminator. Close the rollers.
3. Turn the HEATED ROLLERS and the TEMPERATURE CONTROL switches to the ON positions. The heated rollers are necessary only during warm-up and may be turned off for most applications when operating temperature is reached.



CAUTION: Heated Rollers are for warm-up only and should be turned off when operating temperature is reached to avoid damaging the rollers.

4. Set the temperatures according to the film manufacturer's recommendations for the film you have chosen. The Finisher 4000 will take approximately 10 minutes to reach operating temperature. The roller and shoe temperatures are indicated on the LCD displays on the control panel.
5. Turn the FANS switch ON. This allows for a clear lamination by cooling the film as it exits the rollers.
6. Turn the MOTOR switch ON and perform a test mount to ensure proper settings for successful mounting. If any adjustments are necessary make them now and run another test. Repeat this step until you obtain desired results.
7. Position the print to be mounted on a section of mount board up to ½" thick behind a leader board. The leader board will prevent compression of the leading edge of your mount board.
8. Feed the print and mount board into the laminator behind the leader board slowly and evenly. **Be sure to pull back the release liner before it enters the rollers.**
9. You may mount subsequent prints now, one directly behind the other so that the board in front becomes the leader board.
10. Once your last print has completely exited the laminator, turn the MOTOR switch OFF and use the trimmer on the rear of the laminator to remove the mounted and laminated prints.

IX. Maintenance/Service...



Always use caution when servicing your laminator.

Precautions:



Disconnect the power supply and open the panel breaker before attempting to service or repair the laminator.



Any maintenance or service should be preformed only by those having appropriate technical training and experience. Contact the manufacturer at 800-572-2144 for training information or technical assistance.



Adjust only those controls that are specified in these operating instructions.



Use caution when installing and removing the feed table as it weighs about 30 pounds.

Cleaning Rubber Rollers:

Excessive build-up of adhesive on the rollers may cause poor lamination quality and erratic film movement. Use the following procedure to remove any adhesive from the laminating rollers.

1. Turn the HEATED ROLLERS and TOP & BOTTOM SHOES OFF and ***allow the laminator to cool.***
2. Cut the film where it comes off the top and bottom supply rolls. Pull any film out of the laminator and away from the heat shoes.
3. Carefully remove the feed table and heat shoes to access the rollers. The feed table is heavy and removing it exposes hot and moving parts.
4. Disconnect the power supply.
5. Clean the exposed section of the rollers with a soft cloth dampened with an appropriate cleaning solution such as isopropyl or denatured alcohol.
6. Reconnect the power supply and turn the FORWARD/REVERSE switch to the FORWARD position. Turn the MOTOR switch to the ON position momentarily to expose a new section of the rollers.
7. Repeat steps 3-5 until the rollers are thoroughly clean.
8. Allow the rollers to dry completely before rethreading the laminating film.

Cleaning Heat Shoes:

Clean the heat shoes periodically to avoid adhesive build-up. Build-up can inhibit the film from moving over the shoes smoothly. Use the following procedure to clean the heat shoes.

1. Turn the HEATED ROLLERS and TOP & BOTTOM SHOES OFF and ***allow the laminator to cool.***
2. Cut the film where it comes off the top and bottom supply rolls. Pull any film out of the laminator and away from the heat shoes.
3. Disconnect the power supply.
4. Open the safety shield and carefully remove the feed table to expose the heat shoes. The feed table is heavy and removing it exposes hot and moving parts.
5. Clean the heat shoes with a clean, soft cloth dampened with an appropriate cleaning solution such as isopropyl or denatured alcohol. Since the heat shoe is hard anodized you can use a scrub pad or very fine steel wool.
6. Allow the heat shoes to dry completely before rethreading the laminating film.

Removing Wrap-Arounds:

Build-up on the rollers and heat shoes may cause a film wrap-around, especially when using thin film gauges. Follow the procedure below to remove wrap-arounds.

1. Turn the HEATED ROLLERS and the TOP & BOTTOM SHOES OFF. Allow the laminator to cool.
2. Cut the film where it comes off the top and bottom supply rolls.
3. Open the ROLLER RELEASE handle on the side of the laminator and pull the film out of the unit that has become wrapped around the rollers.
4. If you have a severe wrap-around, it may be necessary to use the REVERSE feature to back the film out. Be sure to pull the film away from the laminator.

X. Trouble-shooting...



Symptom	Possible Cause	Corrective Action
LCDs do not show display when heat switches are on.	No power to laminator Blown fuse	Close panel breaker Disconnect power and replace fuse
Film is not bonding to the print	Laminator not set to optimal laminating temperature Ink on print is wet Paper is too slick	Adjust temperature slightly upward. Allow ink to dry thoroughly Use a more matte paper
Laminated item curls	Top or bottom film tension is too high	Loosen tension on side (top or bottom) that is curling up
Laminated item is wrinkled	Mandrel tension too loose Temperature too high Moisture in paper being laminated	Increase mandrel tension on side (top or bottom) that has wrinkles Reduce temperature Store paper in dry area
Laminated item is blistered	Temperature too high	Reduce temperature
Mandrel tension does not remain constant	Brake nut improperly adjusted Core gripper blade is not preventing the core from spinning on the mandrel Mandrels are reversed.	Tighten nut Rotate film core while holding the mandrel firm to lock the blade into the core. Reverse mandrels

XI. Laminating & Mounting Do's and Don'ts...



- ✓ Read the instruction manual before operating your laminator.
- ✓ Always run test samples before laminating valuable items.
- ✓ Feed the print through slowly and evenly, smoothing it as it is pulled into the laminator.
- ✓ Operate the laminator with two rolls of the same width laminating film to avoid excessive adhesive transfer to the rollers.
- ✓ If laminator is not in current use, lower the heat setting or turn unit off.
- ✓ To avoid damaging the rollers, the heated rollers should be turned off for most applications after the laminator reaches operating temperature. Never feed abrasive materials or metal objects such as staples, paper clips, or glitter through the laminator. Keep sharp objects like scissors and rulers away from the rollers at all times.
- ✓ Once an item has been fed between the rollers do not attempt to alter its position as this can damage the print.
- ✓ Do not stop the laminator before the item has completely exited from the rear to avoid a “dwell line” across the print.
- ✓ Do not clean or service the laminator before disconnecting the power supply.

XII. Warranty & Return Policy...



Warranty:

Your Finisher 4300 is warranted to be free of defects in material and workmanship for a period of 1 year from the date of original purchase. In the event of a defect in materials or workmanship, Banner American Products, Inc. or its authorized dealer, will repair or replace (at their option) the laminator.

Banner American Products, Inc. makes no other warranty stated or implied except as stated above. This warranty does not cover damage to the machine that occurs as a result of misuse or improper handling, or damage to prints.

Return Policy:

If your laminator is not operating properly, first review the Operating Instructions and the troubleshooting guide. If the malfunction cannot be corrected, contact your local dealer for instructions. Be sure to have your machine serial number and date of purchase handy.

If the laminator must be returned to the dealer, it is your responsibility to ensure that it is packaged properly. Shipping damage as a result of improper packaging is not covered under the terms of this warranty.